

Model radio control CARS

ISSUE No. 4

SIX ISSUES PER ANNUM

Price 50p. \$1.50 (US) DM3.50 Fr.F6.00 Glr.3.50 Sw.Fr.3.00

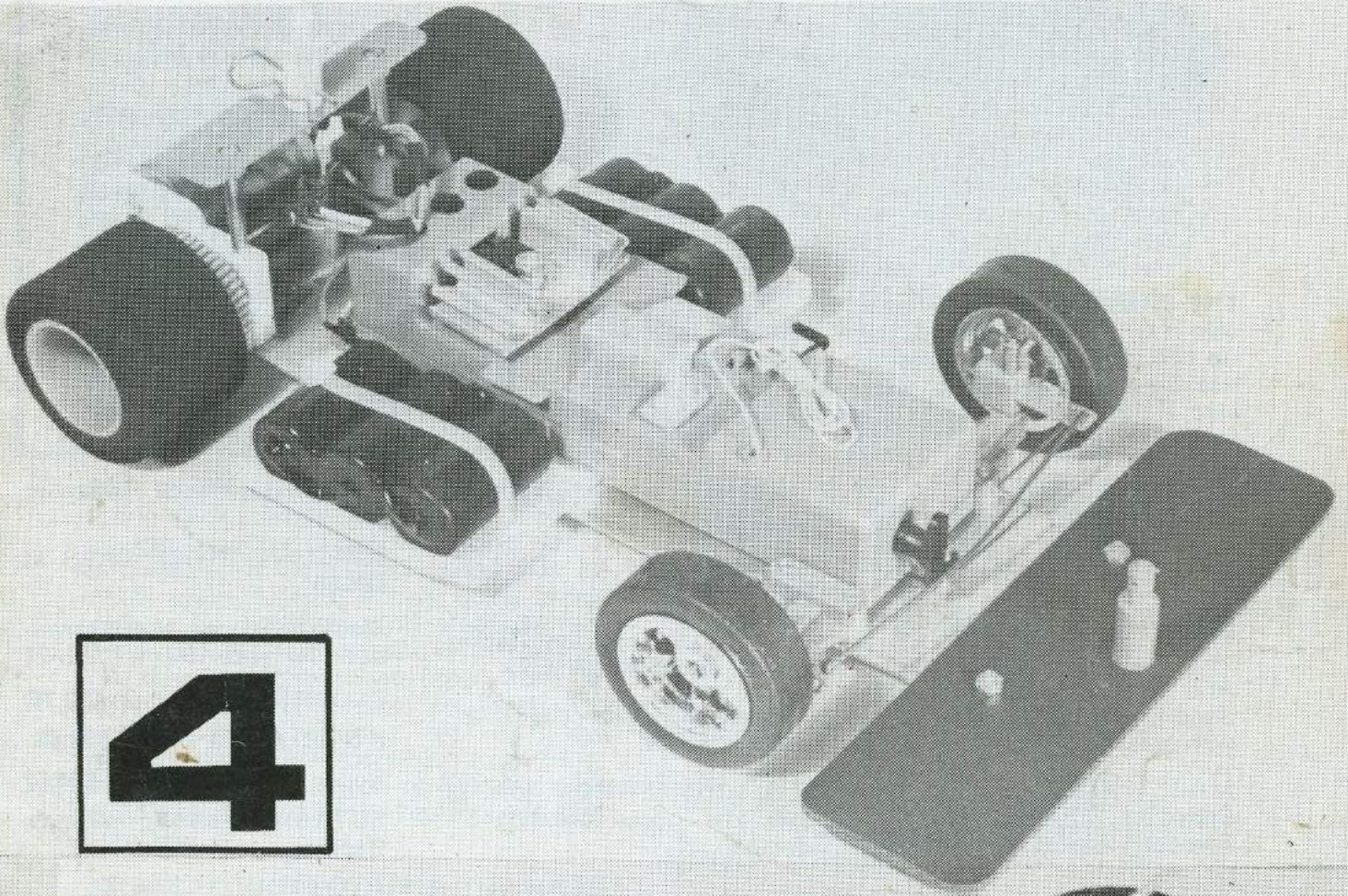

4

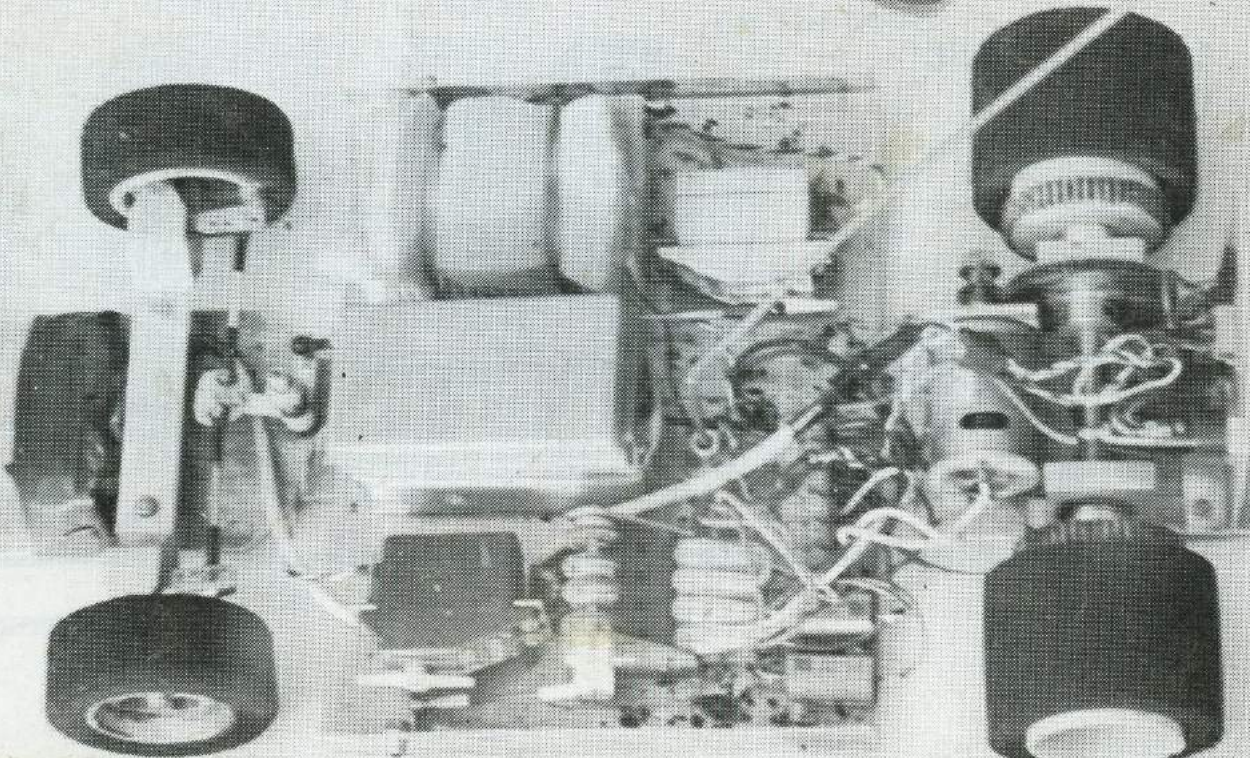

R/C CARS



JUST PHONE YOUR NUMBER

Ted Longshaw for Service & Experience

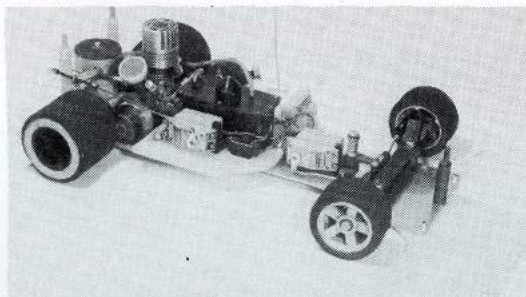

THE BIGGEST range of tyres both 1/12 and 1/8 available in GB from Associated, Delta, MRP, PB, Ultimara, Bo-Link. Quick fill fuel Bulbs, etc., etc., the list is endless. Delta servo arms, Disc Brake kits from PB, Associated, Delta & H.R.E. Thorp Differential axle and wheels available to order.

Kits in stock include:-
ASSOCIATED (U.S.A.) Full range from RC2 at £35 to the NEW RC200 at £105
DELTA (U.S.A.) from CJ750 at £45 to New CJ770 at £89

ALL SPARES BY RETURN
Send for Cat. (50p) refundable with order to

MAIL ORDER address 80 PEPYS Rd., S.E.14 as below. European Export No Problem.

1/12 ELECTRIC CARS

MARDAVE £37.50
LECTRICAR £44.95
MRP £59.95
SONIC TRONIC SPEED CONTROL (saves 1 servo & rx. nicad) £26.50

Plus many other AMERICAN KITS: Bo-Link, Electrocraft, etc. at prices up to £165, incl. radio and transistorised speed control RTR.

MARDAVE (G.B.) The ideal beginner's car at £23.50

MARKER (U.S.A.) The Engineer's Car. Expensive!

P.B. (G.B.) from the Racing Double at £29.50 to the '77

Car of the Year the International at £75

S.G. COMPETITION kits at low, low, prices including ST engine

Whether you're an experienced r/c modeller or a complete novice you should know:

1. We have unrivalled World-wide experience to help and advise you.
2. We stock all makes and, MORE IMPORTANT, THE SPARES FOR ALL MAKES!
3. We have the largest range of ABS, Butyrate and Lexan Bodysells in 1/12 and 1/8 scale available in this country
4. Our temporary showroom (prior to completion of negotiations on shop) is open by appointment at any time at Biggin Hill, Kent. Ring 0689 (London 66) — 55313

H.R.E. from Chuck Hallum at £75

MARDAVE STOCK CARS at £23.50

McCOY Spares and Conversions for Veco 19 and K 7 B 21

ENGINES Veco 19 (car) £22.75; K & B21 £47.50; OPS21 £39.95

Super Tigre X21 (new) £44.57

FUTABA Steering Wheels Radios

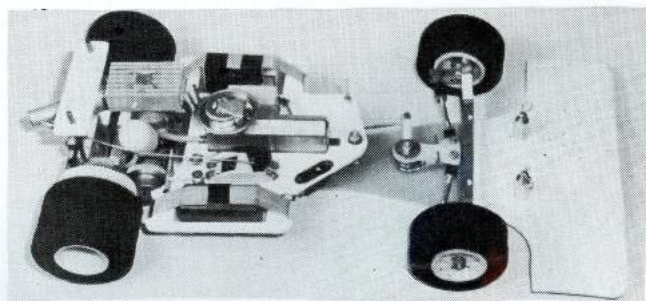

The New RC200, £105

80 PEPYS ROAD, LONDON SE14 01-639 5080

radio control

MODEL CARS

Published by L-D EDITORIAL & TECHNICAL SERVICES LTD., P.O. Box 30 HEMEL HEMPSTEAD, HERTS., HPT 1NL. MARCH 1978.

Editor: "Dickie" Laidlaw-Dickson

MORE PAGES . . .

WHEN I first bruited the idea of this magazine my more pessimistic friends asked what on earth I would find to put in it every issue. This has not as yet proved a problem, rather the other way round, how to get it all in without losing desirable detail. With this issue for the first time contents have burst their bonds and there are eight more pages than is our wont. Obviously an increase in advertisements helps us to pay the bills (thank you advertisers) but two-thirds at any rate is extra editorial matter. No promises that this can be repeated, but we hope it will.

R/C DRAG RACING

R/C drag racing enjoys a class of its own in ROAR racing circles in U.S.A. but has not so far achieved a comparable position in the U.K. Santa Pod Raceway — see letters — would seem to be amenable to staging some demonstrations during slack periods . . . all that is needed is a get together of would-be and actual enthusiasts. It is a sensational side of motor sport fullsize, allows quite exotic ideas to be displayed, and produces fantastic acceleration to clock the quarter mile speeds. Requirements (apart from the car) in r/c model size are first and foremost the "Christmas Tree" of timing lights, a suitable strip on which to perform, and some agreement on preliminary rules (ROAR regs could be the basis). Let's hear from you . . .

MONACO WORLD CUP & THE NATS

We hope to be in time to publish the forty-eight drivers who have been invited to race at Monaco over the Saturday/Sunday 27th/28th May. It looks like being a star spangled turn out with some American drivers competing for the first time ever in Europe, plus some European

unknowns outside their own countries, plus all the names that make news. Tragically, it clashes with the British Nats. at Wombwell, and some difficult decisions must be made. I must put my point of view straight away, that possibly such a meeting may never be possible again, with such talent in such a spot, and will be making every effort to be there for the two lead-up practice days, and the actual contest period. This means I cannot cover the Nats as well, and must rely on a suitable "stringer." Anyone with a good camera sense, a knowledge of the game without being too preoccupied with winning a slice of it, is welcome to offer their services in this connection.

ROGER TAYLOR-MADE PLANS

First pilot run of Roger Taylor's one-eighth (repeat 1/8th) scale plans are now ready and available at £2.00 per car, including postage and VAT, comprising detailed four-view (plan, side, front, rear) plus additional small sheet containing sections and general dimensions. Three cars are available: 1977 F.1. Ferrari 312 T2. Niki Lauda World champion car and driver; 1977 Alfa Romeo T33 SC/12 Group 6 World Champion Car; 1977 Porsche 935/77 Group 5 World Champion Car. Appropriate decals are shown in place.

How the series develops depends of course on you the customers. Within the range of available data Roger will draw up any car that has the appropriate "customer potential" . . . Now tell us.

ON THE COVER . . .

MRP's "full house" 1/12th scale electric, here shown in its most advanced form with radio, servos and everything complete — note the cooling fins on the speed controller. Below: Scratch-built 1/8th scale electric, prototype of Trainer in this issue.

CONTENTS : CLUB AND TRACK REVIEW..5 ELECTRIC "TRAINER" ..10 Associated RC100 ..18 R/C CAR SWISS STYLE ..24 STEERING GEOMETRY ..26 BRITISH ELECTRICS ..30 NEW FROM NUREMBERG ..34 LITTLE BIG CAR FROM SG ..40 STOCK CAR NOTES ..42 RADIO STOCK CAR ASSOCIATION ..43 Midlands E.R.C. ..44 SHOPPING AROUND ..46 CHESSINGTON ..49 LETTERS ..50 EFRA ..52 RACING CALENDAR ..53 LONDON'S OWN ..38

4

Serpent

ak II

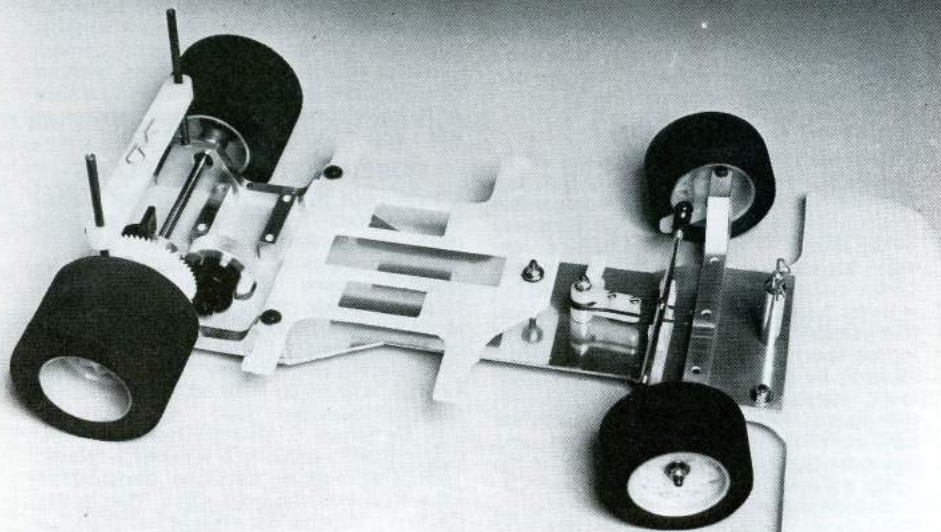

**THE CAR WHICH BRINGS YOU
TO THE EXPERTS**

F.W.F.

F.W.F. model engineering b.v.

bakenessergracht 21 - p.o. box 614 - haarlem - holland



dealer and distributor inquiries are invited
RADIO CONTROL

CLUB & TRACK REVIEW

Lounge Car Racing Club

Secretary: Tim Walden or Tony Wise
10 Amberley Road
Hartwell, Northants.
(Tel. Roade (0604) 863122).

Tim Walden writes: "We race one-sixteenth scale r/c cars in our homes. We started about a year ago and now have good nucleus to our club. We have organised race evenings every week and are now looking forward to expanding our numbers. Cars are scratch built with bodies from plastic kits and make up into very good looking cars. They are built to a formula, so performance depends on handling and cornering rather than the best motor. Suspension, gear ratios, differentials (Ed.) are all up to the entrants, yet a basic car can be built without previous modelling skill and work very well.

The Formula: (1) 1/16th scale sports racing cars (2) Milliperm Special motor 6v. (3) Proportional steering and forward/reverse (4) Nicad cells. Up to 5 x HP7 size (5) Minimum weight 20 ozs. The advantages: (1) Race at home or in the club. (2) Results by skill not money. (3) Cost only £20 (less radio). (4). Easy to build and maintain. (5) All electric — no fuel problems. (6) Needs no airfield/circuit or weather. (7) No running costs. (8) No noise or interference. (9) No large expensive track. (10) You can drink and drive!

Cars have proved to be very reliable and the running costs are nil so it makes an ideal sport for busy people who are not rich. A track and a few cars liven up any club night with racing of up to twelve cars. We would like to invite anybody interested to contact us with a view to attending an informal race evening as co-driver to try out our cars in either Milton Keynes or Northampton areas.

Dorothy Hyman Stadium Wombwell
Model Car Circuit
Lap Length 266 yards
Long straight 20ft. wide
Balance 12ft wide plus concrete edge

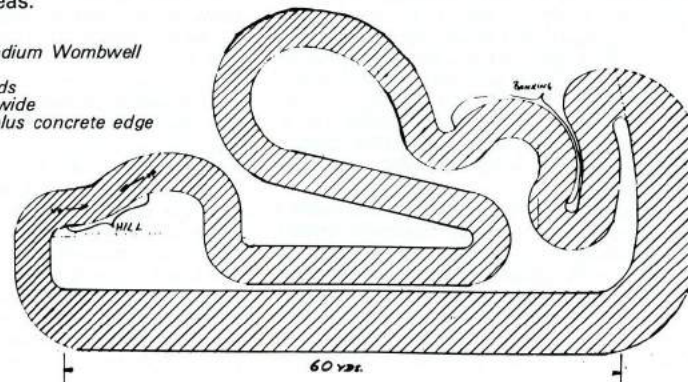

Sitting it out at the Lounge Car Club!

Wombwell Sporting Association R.C. Model Car Club

Secretary: Stephen White,
13 Derwent Drive,
Chapelton, Nr. Sheffield. Tel: 62595.

As Wombwell is to be scene of British Nationals this year, readers will be interested to see the design of the enlarged circuit, which offers a 20ft. wide straight some sixty yards long, passing in front of the drivers' rostrum, with a small hump-backed hill away on the left, a sharp hairpin directly across from the rostrum, then a sweeping three-quarter circle to come into a banked wiggle and two more op-

posite lock hairpins to return to the straight: or the other way round if you go anti-clockwise. Its 266 yds. (all bar the straight 12ft at least wide) look to have the makings of a most sporting and demanding circuit, though opportunities for pre-nationals practice may be somewhat limited.

Ally Pally Electric Car Club

Secretary: Jane Adams,
79 Northumberland Road,
North Harrow, Middx. HA2 7RA.
Tel: 01-866-5945.

This foundation meeting place has now resolved itself into an active club with full quota of officers and committee and even a monthly newsletter, the first of which has come to hand. This lists meetings through January, one only in February and five in March. Details of the Winter Championship are published. Rules introduce no novelties. Starts will be at 20.10 (10 past eight to you) Eight cars per heat. Penalties for missing a tired corner or cutting it out amount to 5 secs. a go. At 10.30 pm times will be sorted and 12 fastest heat times into Semi and Final. Four direct entries, plus first four placed in Semi to go to Final. Final run in two grids, fastest four front and the semi-final four behind. Ten laps throughout on the new course here shown.

Club membership costs £5 per annum. Associate (non-racing) £1. Racing £1 per meeting. Newcomers get their first go free! Where does the money go? First to provide a new Race Timer (the one on loan will have to go back) and after that charges will be reviewed.

Woodspring Radio Auto Club

Cold but dry weather greeted the hardy few who turned out for the New Year's Day meeting at the Mendip Circuit at Bleadon. Further filling in and consolidating work had taken place, but there were still hazards which will disappear as weather improves and the full treatment can be given. A large flat roofed hut (ex-builders' site office) will house time-keeping and other essentials, with drivers' rostrum above, giving splendid view over the circuit.

Following four five minute heats came a 30 minute final in the Formula event, results being: 1 Dave Martin (Lilford) 82 laps Colin Englefield (Coventry) 60 John Beddis (Woodspring) 54 Ron Major (Woodspring) 52 Martin Sims (Woodspring) 50 Phil Smart (Torquay) 17● ●Deacs gave up! Bad luck.

Scunthorpe Area Modellers Association (R/C Model Car Section)

Secretary: J. W. Codd,
"Dunvegan" 94 Appleby Lane,
Broughton, Nr. Brigg. Tel: Brigg 54556.
South Humberside. DN20 0AY.

Formed as recently as last July club has forty members, with thirty cars built or in course of construction. Happily they were able to take over an area recently vacated by a local Go-Kart club, on an old aerodrome site about eight miles out of Scunthorpe at Blyton airfield. The track is situated on one end of the old main runway and is permanently marked out with yellow line paint which makes for good visibility under most light conditions. Average width is 12ft., lap length about 185 yds., with a 70 yds. straight. Surface is smooth without bumps and finished in a tarmac/stone mixture, but weathering has caused slight settling of the tarmac, leaving the stone a few thou. proud, making it a little difficult in the wet.

Standard equipment has been Veco/Mardave, but with growing skill members are starting on more exotic hardware! Track open for practice at any time; official practice Thursday evenings (summer) and Sundays. Racemeetings held monthly — dates appearing in the club's bi-monthly news letter. Members still welcome — contact the secretary.

Southern Radio-Car Club

Secretary: Peter Wooldridge,
6 Patricia Avenue,
Worthing,
West Sussex BN12 4NE.

Now fully established, with race meetings almost every fortnight at the Cjatsmore Raceway, Goring Street, Worthing. About a dozen stockers are now regularly racing, on an oval circuit with 30ft. straights, 16ft. diameter inside track ends, and a track width of 8/9ft. Plans are afoot for the use of a second site, which should provide some variations and interest for competitors.

Constantly adding to and improving trackside equipment, and currently negotiating the rental of advertising banners, etc on track run-out barrier. Other forms of fund raising are in hand, and the club would be interested to hear how other clubs raise extra cash (apart from membership fees, entry fees etc).

Club Championship opens on Sunday March 26th to full club members. In an effort to keep the standard of cars high, Godfrey's Model Centre of West Worthing have donated a Concours Cup to be

awarded at all meetings. Associate membership is available to members of other car clubs at an annual fee of 75p, and we anticipate holding many Open Meetings throughout the year, with a Championship Trophy to be awarded at the end of the series. Enquiries please to sec. with SAE.

Liverpool Tigers Model Car Club

Secretary: George Whittle,
77 Blantyre Road,
Wavertree, Liverpool 17.
Tel: 051-733-9460.

Appeal in Issue No. 2 by P. M. Noone has resulted in the formation of a club complete with circuit! Though not exactly as one optimistic member thought actually at Aintree but at the Queensway Carpet Warehouse, Yew Tree Trading Estate, Haydock. The track is 140 yards long, with a 50 yards straight. For more details contact secretary as above.

Wansdyke Electric Radio Car Club

Secretary: Mark Burrell,
65 Hurn Lane,
Keynsham, Nr. Bristol,
Avon BS18 1RS. Tel: Keynsham 4308.

Young Mark Burrell has begun to get his club off the ground. First effort proved much too expensive, a local comprehensive school track in the gym would have cost £5.50 per hour alas! A local toy shop is now stocking Letricar bits and pieces (Eric Snooks Model & Toy Shop in Bath) which is a local bonus. However, suitable and modestly priced venue still required. As much as members, Mark would be glad to hear of possible places. Proposed membership fee is £1.50 per annum, plus 50p entry fee for races, as when and if the venue arrives. Local experts please help!

Northern Ireland Radio Car Association

Secretary: Matthew Evans,
12 Tullymore Park,
Ballymena,
Co. Antrim, N.I.

Formed in September 1977 the club has been racing on a large school playground for the past two years, but without actually forming a club until size and interest developed. Secretary Evans then approached the local council and the local Recreation Officer with a view to obtaining a proper race track, with the happy result that a former local Go Kart circuit which has been adapted and resurfaced and corners banked has been placed at their disposal and will be in use by the time this is published.

Studley Model Racing Association

Secretary: Paul Dudley,
2 Redditch Road,
Studley, Warks.

Studley r/c car club is predominantly Stock Car (see their members' report on the Dutch Championships in this issue) and being near Stratford-on-Avon rather naturally favour Puma cars made just up the road by B. T. Williams at Alcester. They are not affiliated to BSCA and generally race to rather more open rules without limit on engine price but rather on its nature. By arrangement with the local authority they have regular Sunday use of a local car park, plus a midweek evening meeting in the summer on Tuesday or Wednesday nights. Their own "Championship size" track, longer ellipse about 70/80ft., can be quickly set up with stout outer retaining boards bumper high and lower inner oval. They also set up at school fetes and other invitation occasions.

NEW CLUBS IN THE OFFING

Stafford — Stone — Uttoxeter

Dave Bran, 11 Amblefield Way, Parkside, Stafford is forming a club in the above area to run stock cars under RSCA rules. Use of suitable sites for tracks has been obtained and a build up of membership now sought. Interested parties please contact Dave as above or telephone Stafford 53772.

Lincoln

Wally Liles, 34 Wisteria Avenue, Brantston, Lincoln LN4 1QE (Tel. after 6pm or weekends Lincoln 791753) is attempting to organise a club for Lincoln and district. A track site has been negotiated on the car park of a local social club. Would-be members should contact as above.

Oxford

M. Dowsett, Corringham House, 87 Burford Road, Carterton, Oxon (Tel. 0993 - 841258) interested in forming club in Oxfordshire. School playground intended for track — all that is needed is members in the area.

A Club Sought for Milton Keynes

Paul Burrell, 28 Caithness Court, Bletchley, Milton Keynes, would like to hear from people in that area interested in forming a club to develop 1/12th scale electric indoor (winter months) and 1/8th scale electric (summer). He has been running on a local car park for the past few months and believes there should be enough interest, in spite of the existing (this issue) Lounge Car Club for 1/16th,



THE NAME THAT STANDS FOR SPEED & POWER

SUPER Tigre

X21 CAR
£44.57 (inc VAT)

Large stock of spare parts held at Watford for both Super Tigre and SG Racing Cars. We are the official outlet for Sabbatinis cars in the U.K.

Since its arrival last year the Super Tigre X21 has been the pacesetter for other manufacturers to follow. A rugged construction able to cope with the arduous conditions of competitive car racing. Just compare the specification with the opposition. An ABC piston assembly with light-weight piston, bronze bushed bigend conrod, heavy duty 12mm dia. crankshaft running in double ball bearings, specially diecast crankcase not a conversion from aircraft motor, large bore carburettor with the superb idling of all MAG series carburettors, deep finned heat sink, squish band head. BHP .75 at 25,000 rpm, weight 9 1/4 oz. Used by most of Europe's leading drivers.

SUPER TIGRE MOTORS ARE AVAILABLE FROM THE VERY BEST MODEL SHOPS



WORLD ENGINES

LIMITED

97 Tudor Avenue, Watford, Herts. Phone Watford 42859

Visitors by Appointment

S.A.E. with enquiries please



Weston-super-Mare 26265

9 THORNBURY ROAD,
UPHILL,
WESTON-SUPER-MARE,
AVON BS23 4YE

Are pleased to announce they are now distributing 'P.B.' R/C Car Kits and Accessories to the Model Trade



| R.C. CARS | |
|--------------------|-------|
| | £ p |
| P.B. International | 75.00 |
| P.B. Expert Comp | 61.38 |
| P.B. Expert STD | 45.04 |
| P.B. Dual | 29.18 |

| R.C. ENGINES | |
|--------------|-------|
| Veco 19 | 22.75 |
| K & B 21 | 47.50 |
| ST X21 Car | 44.57 |

| BODIES | |
|--------|-------|
| ABS | £3.00 |
| Lexan | £8.00 |

'Dustbin' Silencer to suit Veco, S/Tigre O.P.S., etc., £7.65 (K & B m'fold £2.90 extra).

P.B. Slide Carb, £14.00.

PHIL GREENO MODELS LIMITED

9 Village Way East, Rayners Lane, Harrow, Middx. Tel. 01-8667770

| R.C. CARS | | £ | p |
|--------------------|--|--------|---|
| P.B. International | | 75.00 | |
| P.B. Expert Comp | | 61.38 | |
| P.B. Expert STD | | 45.04 | |
| P.B. Dual | | 29.18 | |
| S.G. Comp | | 66.72 | |
| S.G. Professional | | 124.55 | |
| Associated RC100 | | 89.95 | |
| Associated RC1 | | 59.90 | |
| Associated RC2 | | 34.95 | |
| Mardave Formula | | 23.75 | |
| Mardave Saloon | | 23.75 | |
| Mardave Stock car | | 23.75 | |
| Ke'jon Stock car | | 29.50 | |

PLUS A large stock of R.C. car spares always in stock including P.B. Associated, S.G., etc.

All prices correct at time of going to press but subject to alteration.

R.C. ENGINES

Just arrived:

| | |
|-------------------------|-------|
| Super Tigre X21 ABC car | 44.57 |
| Veco 19 inc sil | 24.50 |
| HB 20 inc sil | 24.50 |
| Super Tigre 19 ABC car | 36.50 |
| K & B 21 | 47.50 |
| OS 20 inc sil | 25.97 |

ALSO Veco/McCoy conversion parts, including chrome piston/liner assembly, stoker crank-shafts, and High comp heads, etc. Send S.A.E. for price list.

TUNE UP ACCESSORIES

| SILENCERS | | £ | p |
|-----------------------------|--|------|---|
| Semco Car | | 6.95 | |
| Semco Car (adapter Veco 19) | | 1.95 | |
| Preston Car Sil | | 7.95 | |
| S.G. Car Sil | | 7.50 | |

| TANKS | | £ | p |
|-----------------------------|--|-------|---|
| PB Quick Fill (4 oz.) | | 2.12 | |
| Assoc. Metal Tank Kit | | 1.95 | |
| Assoc. Chicken Hopper Comp | | 11.55 | |
| New GP Racing Tank (Sumped) | | 7.50 | |

| PB RACING HEADS | | £ | p |
|---|--|-------|---|
| Veco/McCoy | | 7.50 | |
| ST 19 | | 7.50 | |
| ST 21 | | 7.50 | |
| PB Piston Slide Carb 3/8th in. or 7/16th in. Spigot | | 14.00 | |
| Perry 40 Carb. | | 6.95 | |
| Perry 61 Carb. | | 6.95 | |
| HB 20/Veco 19 Heat Sink Head | | 4.50 | |
| PB Heat Sink only | | 1.95 | |
| New GP Slide Carb for K & B 21, OPS 21, ST X21 | | 16.50 | |

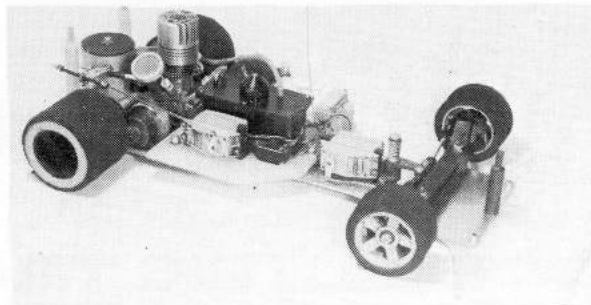

RADIO

| | |
|---|-------|
| Futaba medallion 2FD 22m servos | 69.75 |
| Futaba medallion 2 'brick' | 66.75 |
| Futaba twinstick 2 FD 17m servos (dry) | 93.00 |
| Futaba steerwheel '2' FD 17m servos (dry) | 93.00 |
| Sanwa mini 2 drycell | 54.95 |
| Sanwa standard 2 drycell | 79.95 |
| MacGregor 2 drycell | 61.00 |
| Futaba FD 17m servo (waterproof) | 20.50 |

Nicad conversion for above always in stock.

PLUS Full range of Futaba, MacGregor, Sanwa and Skyleader Radio.

ACCESS! BARCLAYCARD!
HOBBYCARD! H.P. TERMS
PLUS FAST MAIL ORDER.

JUST ARRIVED

| | |
|------------------------------------|--------|
| Lectricar with prop. speed control | £44.87 |
| O.P.S. 21 car engine | £39.95 |

NEW! M.R.P. Jerobee r/c electric, £59.95.

Also large stock of BO-LINK, JOMAC, JEROBEE, ELECTRO CRAFT 1/12th ELECTRIC CAR KITS AND ACCESSORIES.

SPECIAL ITEMS

| | |
|----------------------------------|--------|
| P.B. Air filter | £1.50 |
| S.G. racing tank with sump | £6.95 |
| S.G. servo saver | £2.95 |
| S.G. X.21/racing sil. -80db | £7.50 |
| S.G. Futaba 17m side servo mount | 90p |
| S.G. Alum. air filter | £1.95 |
| Sullivan crap trap fuel filter | 85p |
| Robart super pumper | £11.95 |
| Perry 61 pumper carb | £7.95 |

specialists in **SKYLEADER FUTABA SANWA MacGREGOR**

Opening hours: Mon., Tues., Thurs. 9.30-6.00 Fri., Sat. 9-7.00. Closed all day Wed.

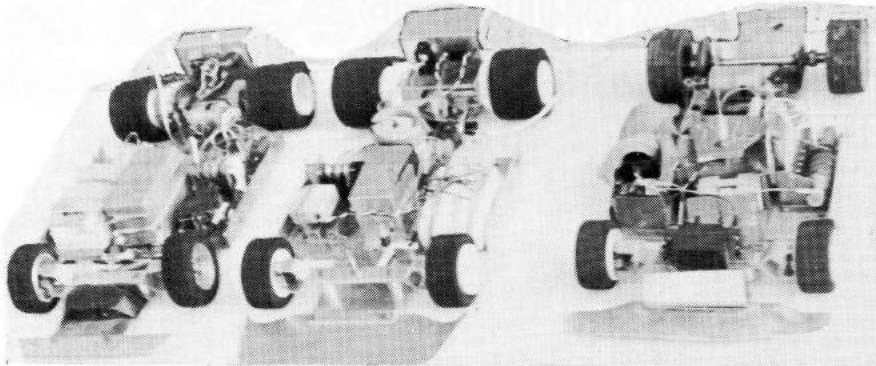

ELECTRIC TRAINER

Above: Left, scratchbuilt No. 2, centre, Mardave improved, right, original No. 1 car.

By Barry Tingay

THE BEGINNINGS

FIRST car built was a present for young son to keep him happy at meetings. It so appealed to others that now there is a growing fleet of them! Just what does this 1/8th electric car have that appeals? It is quiet — so that a spot of practice on a local car park will not bring the neighbours down on you! — it is clean — so that the domestic side of the household is happy — it has reverse, so that one-man training without marshals is so much simpler. It is not noticeably slower than the beginner

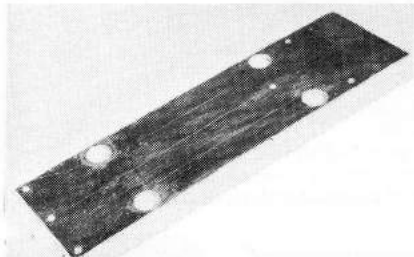

Front chassis marked out and radii drilled, ready for cutting to shape.

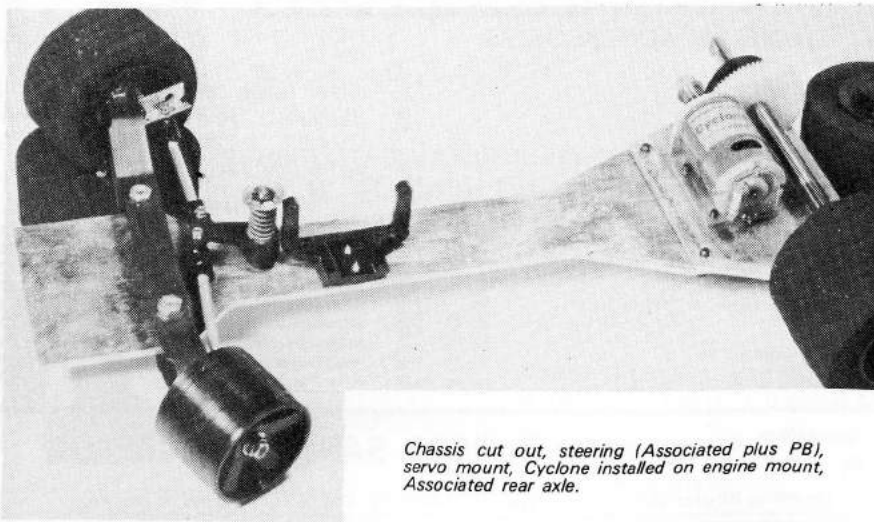

Chassis cut out, steering (Associated plus PB), servo mount, Cyclone installed on engine mount, Associated rear axle.

can handle with glow plug power. It is the same size and style of the glow plug engined car and so robust enough to take its fair share of knocks. It is quickly prepared and can be put away without an elaborate clean-up. Disadvantages? Shortish run without re-charging (say 8/10 minutes) as against nearly twice this time without re-fuelling. Even this can be countered with a spare set of nicads readily changeable.

This first car was Mardave based — a good economy measure. Probably many would-be builders will have the bits and pieces of a car and need not purchase everything from the start. After the successful debut of Car No. 1, my second was scratch-built using Mardave axles, with the addition of ballraced plummer blocks at rear and ballraced wheels at front. Some cleaning up of layout also took place. At least two other cars were also either built entirely, or watched over and advised upon when made by club members.

BUILDING THE TRAINER

Next step was to send for Ted Longshaw's catalogue and treat myself to an Associated Front Axle Kit (No. 1210). When fitted to Car No. 2 the handling was vastly improved. This decided me to build a completely new car as now described. Chassis is in two pieces, power pod and front chassis plate. Motor is Cyclone 15. In passing, when skill and ambition has been acquired, a simple change of power pod and you can be glow plug racing with the

minimum of effort.

Chassis is made very stoutly from Aluminium Alloy HE15 TB 1/8in thick, 18in. long and 3 1/2in. wide. Cut off one end 4 3/4in. long, making due allowance for squaring the ends: this is the power pod. I used Spectra blue to aid marking out. Scribe centre line of rear axle and centre line of car. Mark out, centre punch, and drill the holes and the slot for gear clearance. I drilled 3/8in. holes at each end and two between them, and sawed and filed the slot.

Deal with the front chassis plate in a similar way, squaring one end and marking out from there, coating with Spectra blue as before. Mark car centre line, and all holes to be drilled, working from rear squared end which will attach to pod. Front is left to last and cut off and squared at the very end. The 3/8in. radii at the junction of the chassis waisting were made by drilling a pilot hole, and then drilling out with a 3/8in. diameter counter bore. Chassis was then sawn and filed to shape.

Motor bracket was made from a piece of 2 x 2 x 1/8in. alloy angle. All the holes are marked out from the centre line, the 3/8in. dia. hole was again done with the counter bore. After all the holes were drilled and tapped motor was tried in place to check that it could be swivelled for final gear mesh adjustment.

Power pod is joined to chassis plate (pod on top) with 2BA button head or countersunk screws coming up from underneath. Two nuts go on the outer two

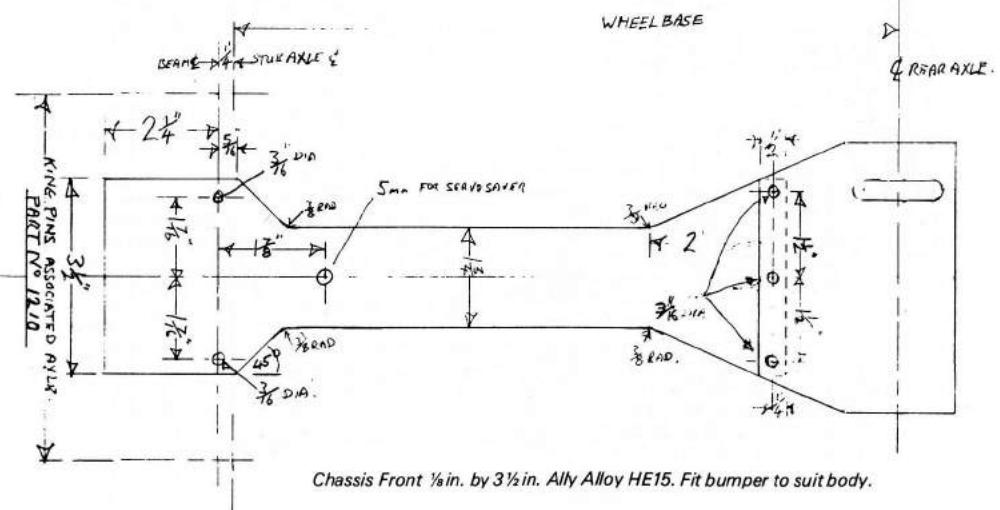

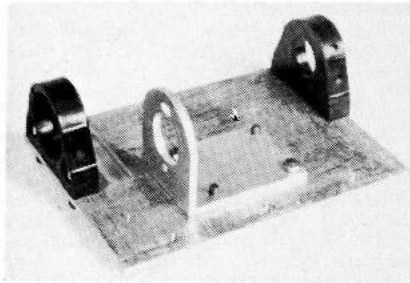

Engine pod with motor bracket and plunger blocks in place.

screws, which also hold the radio plate, secured in turn with two more nuts.

Ballraces are pushed into their housings, with the races on the outside. The axle is located with the short turned end against the ballrace. The gear is then pushed out to the other ballrace so that when the bearing blocks are tightened there is no side movement. Screw down retaining grub screws to mark axle, then take down assembly and drill a dimple into which grub screws can locate. Re-assemble, tighten down, and adjust motor to correct gear mesh.

Motor in place with gears in mesh.

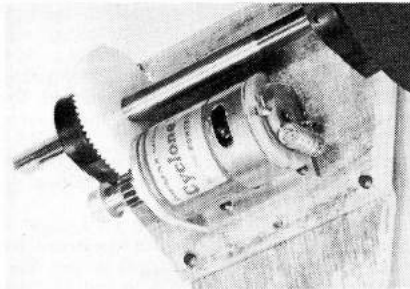

Power Pod 1/8in. ally alloy HE153 1/2 x 4 3/4 ins.

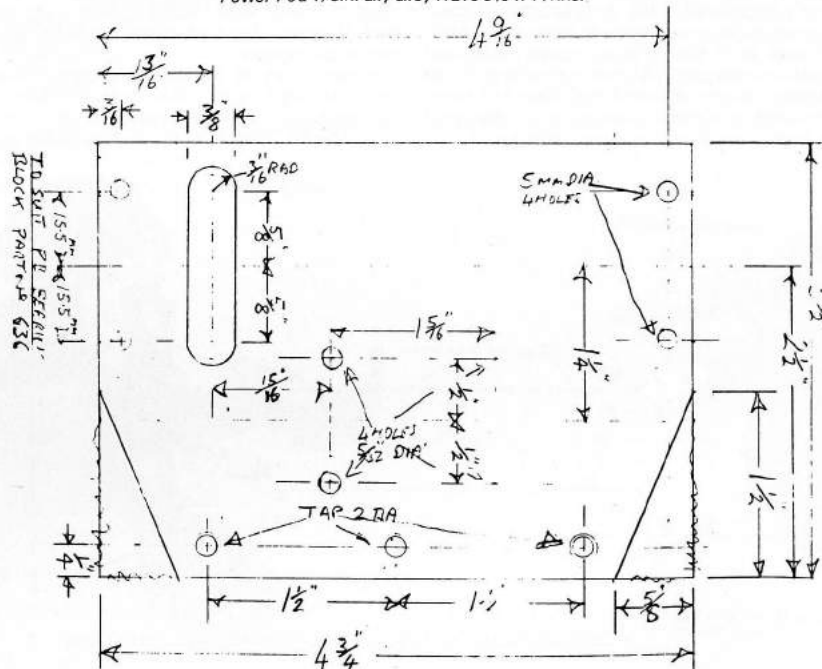

FRONT END

When fitting the steering cross arms, the lower unit should go under the chassis, the two spacers on top, then the upper cross arm. This will tilt the stub axles very slightly to provide a small amount of camber. If Associated wheels are used they go straight onto the stub axles. With PB wheels the stub axle bushes must be slightly shortened and rubbed down with fine emery to make a good running fit.

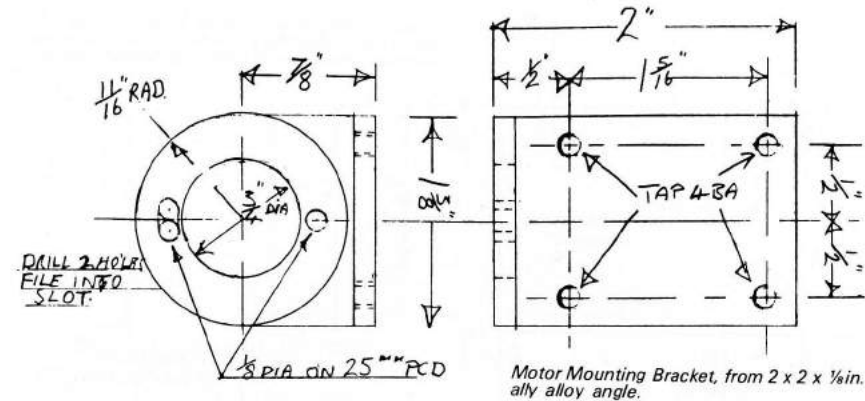

SWITCH ASSEMBLY

This may be new ground for many but requires only care and patience. Cut and drill the two side plates. They should be drilled together as a pair. Bending must provide opposite handed pieces, a left hand and right hand plate. To get the bends right, put them in the vice one at a time, and on top of the vice check with two pieces of 1/4 in. tool steel (or any similar true 1/4 in. material) that exactly a 1/4 in. is sticking up. Remove the measuring pieces and fold the flange over, using a block of wood and a hammer. If you have not done this sort of work before, practice with a bit of scrap sheet to get the hang of it.

Cams are from 0.6in. dia. ally alloy rod, cut off 3/8in. thick. Flats are filed exactly as shown on the drawing. Note that holes are drilled and tapped for locating screws are all in the same relative position at neutral (as drawn). I have shown caphead screws holding them in place to make the photo clearer, allen screws do the job more unobtrusively, and are equally adjustable. These press down on the micro switches to provide the various speeds. With these parts made a trial assembly fit-up is next step, using two lengths of 6BA steel studding as shown.

When assembling switches slip 6BA studs through them; put mounting plates on loosely; fit nuts and slide shaft though into place. Stand mounting flanges on a flat surface (plate glass or similar) and tighten 6BA nuts. Remove shaft and put cams on in order, 1, 2, 3, 4. Lock cams 3 and 4 onto shaft so that the flats on them are parallel to each other. Turn the shaft until these two cams are horizontal, that is with the flats above the actuators of the

micro switches. Turn cam 1 until the microswitch operates, then turn it a further 8deg approximately and lock into position. This is the neutral setting. Turn shaft a further 8deg (Approx) and bring cam 2 round until it makes contact with its microswitch and lock in place.

Now when shaft is turned there should be three microswitch movements in either direction. Minor adjustments may be necessary. The sequence is:—

- 1 down: 2 3 4 up = Neutral
- 1 2 down: 3 4 up = 1st speed
- 1 2 3 down: 4 up = 2nd speed
- 1 2 3 4 down = Top speed

For reverse direction the sequence follows, turning the other way:—

- 1 2 3 4 up = Reverse 1st speed
- 1 2 4 up: 3 down = Reverse 2nd speed
- 1 2 up: 3 4 down = Reverse Top Speed

These sequences switch a 1 ohm 25 watt resistor into circuit for 1st speed: 2nd speed switches a further 1 ohm 25 watt resistor into a parallel circuit: top speed switches a bypass lead in parallel with the resistors. Note that switching in parallel halves the value of any one resistor. In our case resistance becomes 1/2 ohm. Resistors should be fixed to the chassis to assist heat dissipation.

Switch assembly operating lever can be filed up as shown from a scrap of alloy bar, or much simpler an old 13amp earth pin from a fused plug is almost the exact shape required. About 30deg each side of neutral is movement required from the usual servo set-up. If when set up car goes the wrong way, then reverse polarity by changing over motor leads.

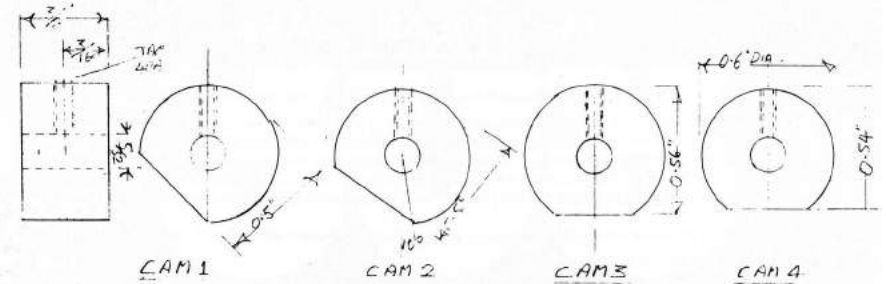
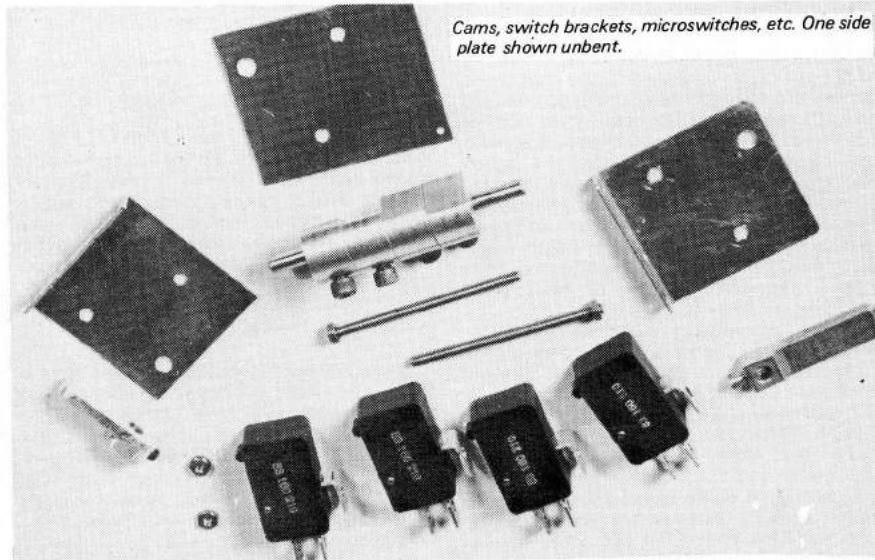
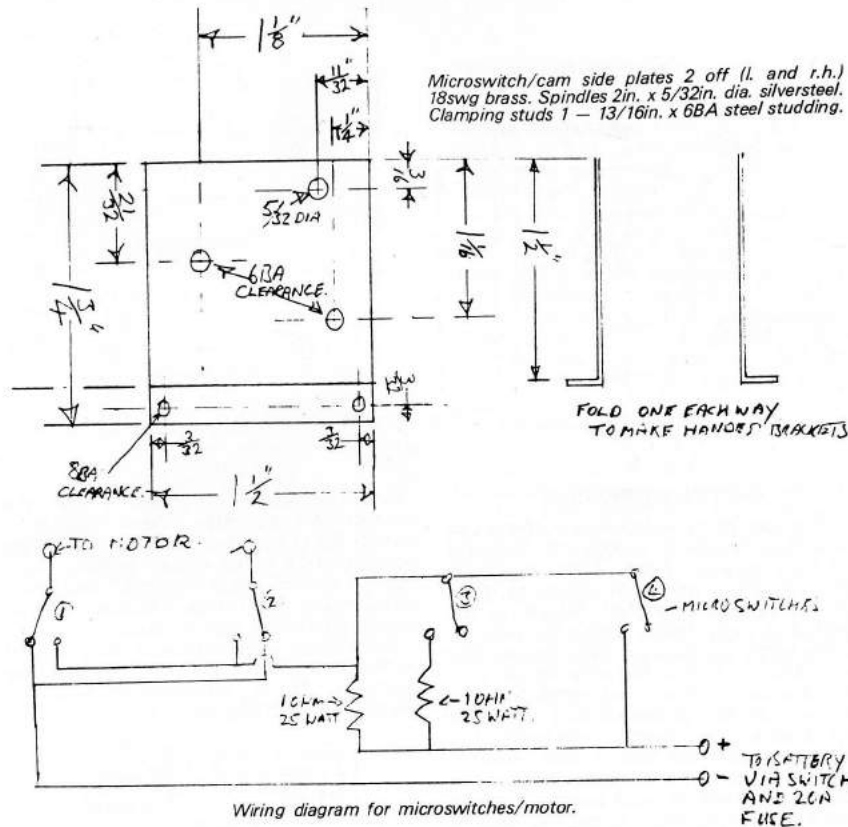

Four alloy cams. Shown set in neutral position.

GEAR RATIO AND FITTING

The spur gear fitted to the motor is 16 teeth 32 DP. It requires to be opened up to $\frac{1}{4}$ in. dia. bore so that it can be fitted to the Cyclone 15 propeller adapter supplied in the motor kit. In the same way the 64T 32DP Delrin axle gear must be opened up to 10mm dia. bore. Boss must be reduced to $\frac{5}{8}$ in. dia. back 0.1in. and holes for two 2BA grub screws drilled and tapped.

Battery pack should be installed as far to the rear of the main chassis plate as possible to keep weight well back.

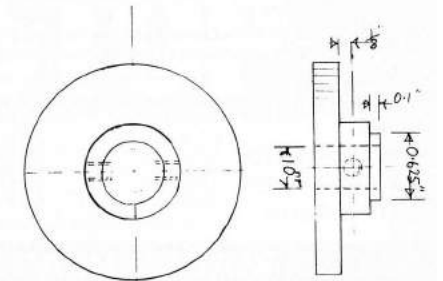
Modifications to 64-teeth 32DP spur gear. Modification to 16T gear: Open up bore to $\frac{1}{4}$ in. dia.

FINISHING THE TRAINER

This covers the parts which can either be made up easily, or that can be bought ready made and assembled. Body fixing, details of radio plate and the like will be very much the personal preference of the builder.

PARTS LIST

Proprietary parts used or recommended are listed below. Some suppliers have minimum orders which may prohibit lone hands from buying though not club groups and in some instances trade supplies only available. To help such people *Radio Control Model Cars* has prepared a list available for SAE of items which the publishers will supply. Some work can also be carried out boring out gears, making up mount for motor, bearing plates and so on for those unable to complete their own.

- 1 off PB Rear axle kit - Part No. 686
- 1 off PB Servo saver - Part No. 683.
- 1 off PB Track rod kit - Part No. 685.
- 1 off PB Front hub kit - Part No. 694.
- 1 off PB Rear hub kit - Part No. 693.
- 1 off Associated RC1 Front End kit - Part No. 1210. (above from Tom Longshaw's catalogue 50p returnable on purchase).
- 1 off Aluminium alloy HE15 TB 18" x 3 1/2" x 1/4".
- 1 off Aluminium alloy angle 2" x 2" x 1/8" x 1 1/2".
- 2 off Brass sheet 18swg 1 3/4" x 1 1/2".

- 1 off *Aluminium Alloy HE15 bar 2" x 6" dia.
- * (NB - size and material not critical, though if dia. changed mounting plate must be re-drawn). (from J. Smith & Son Ltd., Biggleswade).
- 1 off 64 teeth 32 DP Delrin spur gear.
- 1 off 16 teeth 32 DP steel spur gear. (above from S. H. Muffett Ltd., Tunbridge Wells).
- 4 off V3 Microswitches, Part No. 337 - 857.
- 2 off 25watt wirewound 10hm resistors Part No. 157 - 522. (above from R. S. Components - Trade supplies only).
- 1 off Ripmax Cyclone 15 kit (includes motor, propeller adapter, harness, switch, charge led and 8 cell 1.2 amp Nicad battery pack. (above from most good model shops).

Microswitches and Cams duly assembled.

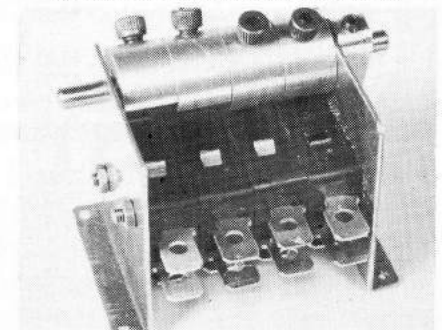

MRM MEANS CARS

(And Fixed Wing Aircraft)

NEW!! McGregor R.C. especially for Cars and Boats £105.00

Wee McGregor has been busy lately and has come up with a set of gear to take all the extra punishment that cars dish out. Keith (Mr. International) Plested has been trying to destroy one but without success. He is so enthusiastic that he's likely to be driving McGregor through this season. This set must be a winner. It is all NICAD, the TX looks like the 3-4-6 function ones but with twin sticks in slot guides. It introduces the new ultra powerful — ultra quick MR12T Servos. These will be available soon as a separate item at about £18.00 each.

A Vinyl TX Cover (Value £5.50) with every above combo purchased before 30.4.78 (Subject to Availability).

Rake out that old 0.9 and stuff it in a.....

1: 12 Scale Lamborgini or Ferrari with this fantastic specification.....

★ Cast Mag-Alloy Chassis ★ All Round Independent Suspension ★ Moulded Tyres on Ally Wheels ★ Ready Coloured Carbonate Body ★ Reverse Gear Operated by Radio ★ Price about £47.00

1: 12 Scale Lamborgini complete with 2 Channel Propo. Radio

Price expected to be under £50 Fantastic Detail. Ready To Go!

For the Kids! R.C. Tank with Radio ready to go £17.00

A Showstopper! Cipolla 3.5cc (Car) £20.30 (Yes. Twenty Pounds/30p).

Ballraced — Schnurle Ported — Deep Finned Heatsink — Screw In Filter — Fantastic Power.

**IN STOCK NOW
RAYDIO TYRES
GOOD VALUE**

| | | | | |
|------------------------|--------|---------------|-------------------|--------|
| P.B. International | £75.00 | Parma Bodies | M.R.P. 1:12 | £59.95 |
| S.G. Comp. | £66.00 | (the best) | Soft Nicads | £1.30 |
| Associated RC100 | £83.00 | Johnson Tanks | 1:12 Lexan Bodies | £7.75 |
| P.B. Junior | £35.67 | Lectricar | S. Tigre X21 | £44.50 |
| Mardave still a few at | £21.50 | Mardave 1:12 | O.P.S. 21 Car | £39.95 |

★ Special Purchase latest KB21 should be in at well under £40.00

MAIDENHEAD RADIO MODELS

Closed Thursdays

55 QUEEN ST MAIDENHEAD BERKS TEL. 37295

Late Night Friday 7.00 pm.

Red Baron Models Ltd.

| | £ | p |
|-------------------------|-------|---|
| Mardave Stock | 21.50 | |
| Mardave Sports/GT | 21.50 | |
| Mardave Formula | 21.50 | |
| PB Dual | 29.18 | |
| PB Expert — Std | 40.23 | |
| PB Expert — Comp. | 56.21 | |
| PB International | 75.00 | |
| SG Competition | 66.00 | |

MOTORS

| | |
|------------------------|-------|
| Super Tigre | 40.87 |
| K & B21 | 47.50 |
| Veco 19 | 22.75 |
| Fuji 19 Schnurle | 25.95 |

STARTERS

| | |
|----------------|-------|
| Sullivan | 27.25 |
| Kavan | 27.20 |
| Marx | 23.40 |

FULL STOCK OF RADIO & SPARES

497 HERTFORD ROAD, ENFIELD, MIDDLESEX

Late night Fri. 7 pm. Easy parking

Tel. 01-804 7452

ELECTRIC R/C CARS

| | £ | p |
|-------------------------------------|--------|---|
| NEW 1/12 scale GLOW PLUG 1 1/2 c.c. | | |
| Lamborghini by Pilot | £47.50 | |
| Lectricar | 44.87 | |
| Mardave | 37.50 | |
| Tamiya Porsche | 34.50 | |
| Sanwa Porsche inc. Radio | 59.95 | |

Jerobee Cars Bo-Link Cars

HEAT SINK HEADS

| | |
|------------------------|------|
| Super Tigre Head | 7.50 |
| K & B 21 Head | 7.50 |

MOTOR & CAR SPARES for Super Tigre, Veco, K & B Mardave, PB, Lectricar, Bo-Link, etc.

ASTRO 05 MOTORS

£5.42
'Phone Your Credit Card Number for same day service

H.P. 10% HOBBYCARD

308 PIT STOP



MARDAVE kits: 1/12th Scale McLaren M23; Lola T294; Capri RS Saloon; Firenza sal; Stock car all complete with clutch £23.75. New from Mardave — Electric Car, complete £38.95.

P.B. PRODUCTS: Expert Junior £35.67; Expert standard £45.05; Expert Int'l £75.00. Expert Competition £56.21. Racing dble £29.30.

Kejon Stock Car £28.50. Lectricar kits £44.95.

SANWA Porsche electric drive complete with R/C function £59.95.

TAMIYA 1/12th scale Porsche-Turbo. Electric drive £34.99.

ENGINES: ST X21 with ht. sink hd. £44.12. OPS 3.5ccs £39.95. K & B 3.5ccs car spec'1 £47.50. Veco 19 car spec'1 £22.45.

ALL MAKES OF R/C EQUIPMENT STOCKED AND FULL RANGE OF SPARES
We accept ACCESS, AMERICAN EXPRESS, BARCLAYCARD, BANK AMERICARD,
HOBBYCARD, QUADBONDS

WORLD-WIDE MAIL ORDER

HENRY J. NICHOLLS & SON LTD.

The World's Greatest Model Shop for the Enthusiast!

308 HOLLOWAY ROAD, LONDON N7 6NP. Telephone: 01-607 4272

(2 mins. from Holloway Rd. Station on the Piccadilly line)

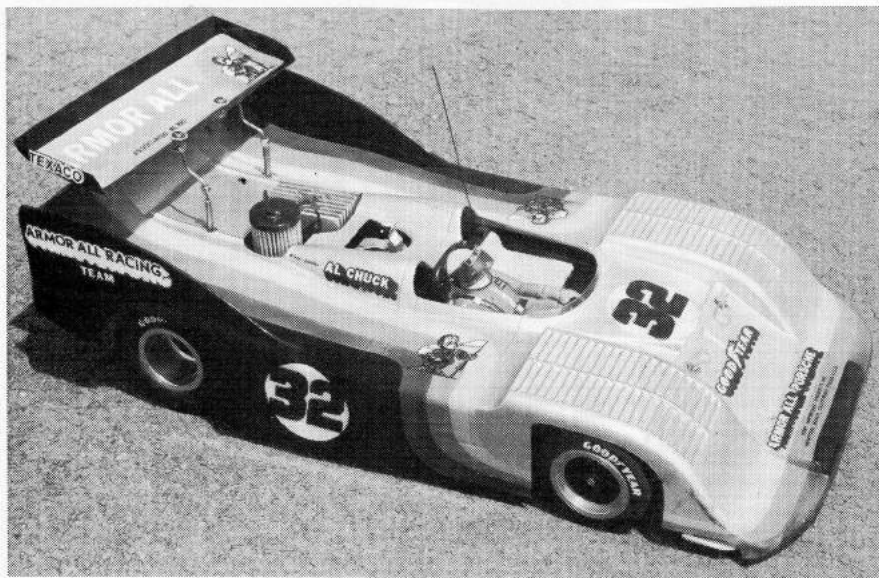

ASSOCIATED R/C 100

WITH A LITTLE HELP FROM THE NEW RC200

HARDLY HAD I sat down to rough out this feature than news arrived of the RC200 a vastly improved version to make all other marques out of date, or so I thought until I had the good fortune to see the advance copy en route to the Nuremberg Toy Fair. Splendid it certainly is, and a future joy and pleasure to many, but, in keeping with the established Associated system, all marques modify upwards or downwards. Briefly, the additions include fibreglass chassis, new front end to provide full Ackerman steering, improved spring-loaded filler cap to tank, thicker rear axle. Any one or all of these mods can be added to existing RC100s. I did not mention disc brake since this is already an RC100 option.

STARTING TO MAKE UP THE KIT

Instructions are splendid as supplied so that it would be idle on my part to rephrase them to make up a feature. Instead it seems better to elaborate on matters which presented some difficulty, or where instructions could have been more detailed. Order of assembly is straightforward: Power pod; motor mounts; brake;

clutch; engine; radio; fuel tank mounting; chassis assembly; front end; servo saver; front bumper; rear/wheels; linkage. This involves quite a bit of jumping about from one end to the other and I preferred to finish off the power pod unit entirely before looking elsewhere, apart from checking that I had all the bits!

POWER POD

Holes are drilled or cut out to locate axle bearing blocks, clutch bellhousing and engine crankcase, with slots to take motor mount bolts, allowing some movement for different gear ratios. Mounts are drilled to take the Veco 19, though this is unlikely to be the usual propellant for most people aspiring to the RC100. However, other engines can, as the book says, be easily mounted by either drilling new holes in the motor mounts, or slotting the holes in the engine itself. The latter course should be avoided if possible since there is seldom a great deal of spare material to allow much more than a little enlargement of holes by reaming out.

Three other lightening holes are also to

End product! Al Chuck's Concours Winner at the Pomona World Championships . . . you can always try . . .

be found on the power pod. A trial assembly of wheels and axle can be made since tyres are happily already bonded onto wheels. This leads to next step, sorting out the standard brakes. A separate instruction sheet is provided for this, which might lead one to suppose is a trifling little job to be done in a tick. Not so; there is first of all the tricky business of the thick steel wire to which brake band is attached. There is plenty of wire and the greater part must be cut off as superfluous. Some trial and error assembly is needed.

Anything to do with soldering that must be firm I view with respect, and try to make up a jig so that the work is held exactly where I want it and I have only to wield the iron. Here the brake band is to be approximately $\frac{1}{4}$ in larger in diameter than brake drum so a piece of scrap wood is cut out to this size in which the band rests snugly. It is drilled and cut so that the wire right angle fixing to the axle bearing block can be located rigidly. Other end of band is bent over as instructed after being rubbed with emery and painted with solder paint (I

use Fryolux but there are undoubtedly other good makes throughout the world) A part of the jig is cut away here to give access to this end.

For soldering piano wire I invariably use Baker's Fluid an acid flux which is ideal for steel (never use it of course for electrical joints!) Since it is acid thorough washing in water afterwards is necessary when it will not corrode. Wire end to go into motor mount can be trimmed to size, but leave enough of the other end for handling purposes, marking with a file cut where it will end in the piece of bent over brake band. File or saw off flush, only after fixing. A good sturdy bit with plenty of heat and a fairly high melting point solder are needed. Repeat **HOT IRON** — the secret of soldering. Get it firmly fixed. If not satisfied, heat, unsolder and do it again. Failure here will be likely to tangle up the car during a race. Clean metal bright and shiny, acid flux, hot iron and a strong job results. If you make no claim to be a solder king, do try with a bit odd bits and pieces to acquire the knack. Like riding a bicycle the knack will come suddenly and you're laughing.

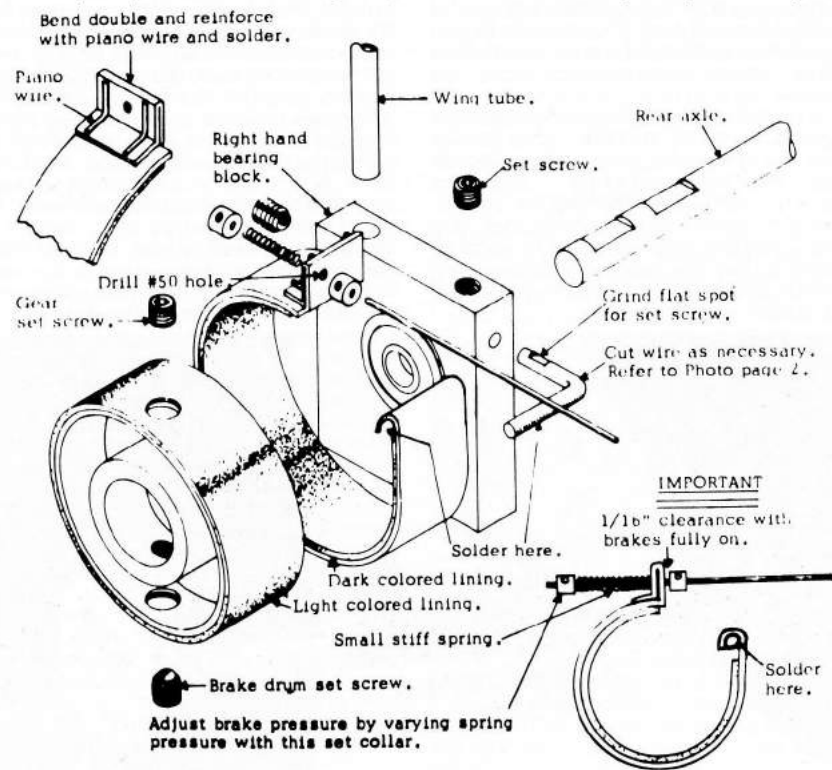

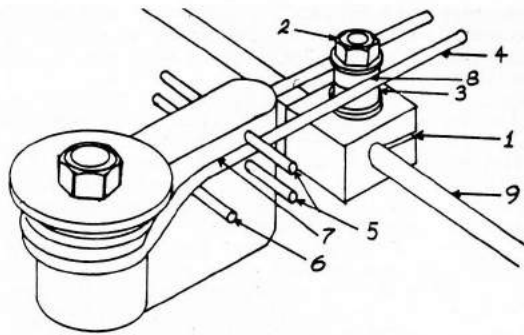

Ball bearing tie rod assembly.
 1. Aluminium block for tie rod : a second hole is drilled to carry mounting screw for ballbearings.
 2. Mounting screw.
 3. Two $\frac{1}{4} \times \frac{1}{4}$ in. OD or $\frac{1}{8} \times \frac{3}{8}$ in. OD flanged ballbearings.
 4. Heavy duty servo saver spring.
 5. Two pieces of $\frac{1}{16}$ in. piano wire to locate servo saver spring.
 6. A further piece of $\frac{1}{16}$ in. piano wire to keep servo saver from tipping.
 7. Spring arms shaped to rest against plastic with about .003in. clearance.
 8. At point where they abut ballbearings. This is **IMPORTANT**.
 9. Tie rod goes into ball ends, and should provide 5deg. toe in. You can also boil the servo saver for $\frac{1}{2}$ hour, slow simmer. Makes it less brittle and prevents cracking.
 Or just fit the latest RC200 steering unit! As pictured below.

For other end a little blow torch flame will melt the solder paint. For the lighter gauge piano wire reinforcement about 20swg will do, bind in place with fuse wire and touch with hot bit using quite safely here a normal cored solder. Remove any bits of fuse wire, and rub down. Final job here is to drill for the brake push/pull rod. Stick the two linings and assemble. After all this palaver, many builders will opt for the disc brake option. It is easier to fit and in common with most views, is I believe better (some motorcyclists may not agree!)

After this fitting clutch, another separate sheet, will be child's play. Do not drop the split-spring pins— now slightly bigger than they used to be — and press them in with a bench vice as recommended. Gently does it! Whether you follow the new mode of metal to metal or decide to line the clutch bell depends on the sort of speeds you expect to attain and the engine you fit.

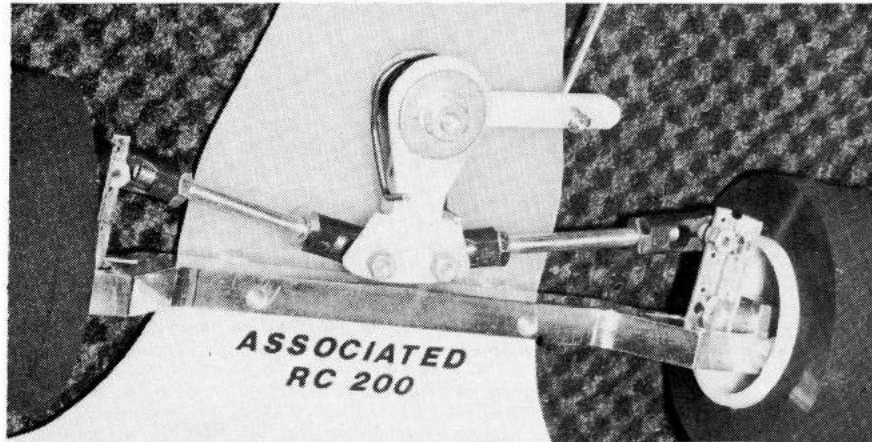

CHASSIS

Some power pods have a recess ground to accept the chassis plate. I have one like this and one without a recess that looks to be an earlier model. Anyway pod goes on top of plate and is duly secured with three nuts and bolts. This would be the end of it but for the plastic radio mounting tray. Originally you had to cut this out to shape, now it comes with cut outs for fuel tank, battery and receiver, leaving only the servo cutouts to make to suit your servos. The two outer securing bolts attaching pod to chassis plate are in fact long bolts on which the radio tray is secured, as per the book. A third bolt at the front of the plate and through the chassis completes the fixing with the proviso that instead of being firmly fixed at the front, a metal washer allows a degree of play to enable the chassis to flex. It all seems a little complicated but is easier in the doing.

HIGHLIGHTS OF NEXT ISSUE OR COMING SHORTLY

SOMETHING DIFFERENTIAL . . .
 All about virtues or otherwise of differential gears
PHIL BOOTH builds a PB International out of the box.
 Making your own castings at home.
BUILDING THE PUMA STOCK CAR.
 First of the Engine Tests : FUJI.
 Start of the New Season . .

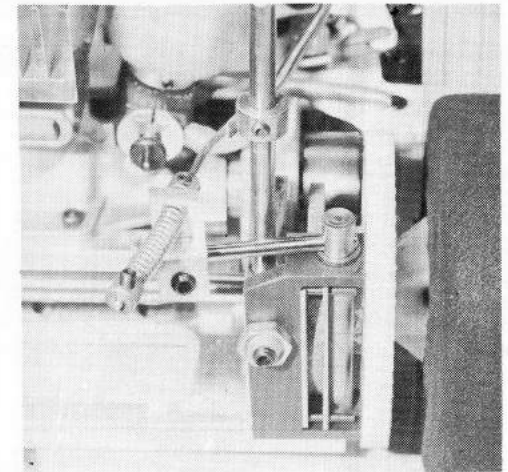

Disc brake unit as now offered as an option. Can be very accurately adjusted for braking effect.

FRONT END

Originally a pair of front cross arms were assembled with the steering blocks and stub axles and then adjusted to be true and twist free. Now a splendid machined alloy cross piece is available into which the steering blocks/stub axle assemblies are fitted. These items are the only remaining thing that could usefully be improved by a single piece casting, nylon moulding or machined unit from the solid (I hope to find time to do it for mine before the season opens).

The steering servo has now been improved in company with the front track rod. The latter now slides through a split block and is secured centrally. Ball jointed ends connecting with the steering arms. A double ballbearing unit rides on the split block and the servo saver arms are located and set between two wires through the plastic and rest against the ballbearings, thus ensuring the sweetest possible steering movement. But, stop! The latest RC200 goes a step further with a radically altered (though still a family likeness) servo saver, plus a pair of Delta(?) tie rods to the balljointed ends. Altogether a much more attractive picture and strongly recommended to the man who enjoys a workmanlike and efficient set-up. To what extent it is more effective than before remains to be seen, but it certainly looks good.

Build in tow-in to suit. Gene Husting is a great one for toe-in and some-times frightens even his friends — but go at least half to three quarters of the way he suggests, you may go the last bit when you see how it works.

LINKAGES

Sketches provided make these very clear — far more than words could. Very little changes will be required if disc brake is fitted, since there is still a push/pull action. Some mods. may be necessary if any of the more sophisticated carbs, such as the Thorp are used. Certainly in this case fit a little bracket to take the auxiliary high speed needle valve rather than leaving it floating free on a fuel lead as I saw a few weeks ago!

THE ODDMENTS

Front and rear body mounts, bumper plate and follow the customary pattern. Choice of heat sink depends very much on personal preference. The "big heads" are for the most part still being hand machined and quite costly. Associated offer an attractive and different combined head style like the slip-on rectangular heat sinks but combining a head; Super Tigre include theirs with the engine. Probably others will be doing the same as the demand heats up in the summer as it is bound to do.

Silencing again is a matter of choice. I would not look further than the "dustbin" offered by PB and Ted Longshaw in several varieties. If fitted in a stand-up position a little extension platform cum rear bumper is worth fitting and neatens off that end as well as strengthens it (This is where you are most likely to be getting the knocks — always assuming you are ahead at some stage of the race!)

Final thought! Nuts that are likely to be nearly permanent fixtures during the life of the car could well be secured with a drop of Loctite.



MODEL CRAFT

**BARCLAYCARD & ACCESS
WELCOME**

5 CROSS STREET, BLABY, LEICESTER.
Telephone Leicester 771397

SHOP OPEN 9-6 p.m. Mon. to
Sat. Closed (all day)
Wednesday

MARDAVE R/C CARS

McLaren M23 F1 £21.50
Hesketh F1 £21.50
Lola T294 Sports £21.50
Capri R.S. Saloon £21.50
Frenza Saloon £21.50
Stock Car Kits £21.50

MARDAVE SPARES —

Mk 4 RACING CAR

CHASSIS Drilled flat dural plate £2.50
Rear axle bracket £0.95
Strap £0.20
Brake unit £0.30
ENGINE MOUNTS Set of 4 with screws
and key £0.85
SERVO SAVER (steering bellcrank)
complete £0.60
FRONT SUSPENSION Complete £2.50
King pins each £0.10
Coil springs each £0.10
Axle, with nylon block each £0.20
3/16 in. nyloc nut each £0.05
FLYWHEEL CLUTCH UNIT Complete £3.50
13t hardened steel gear each £0.20
Bush for gear each £0.06
Clutch drum complete with gear and
cork lining £1.40
Crankshaft adaptor (1/4 in. UNF 6mm or
5mm) £0.25
REAR AXLE each £0.50
Bearing lock nut each £0.07
1/2 in. Nyloc nut each £0.05
WHEELS Front each £0.35
Rear (with integral drive gear) each £0.70
TYRES Front, standard rubber each £0.59
Rear standard rubber each £0.95
RADIO CRATE £1.20
FUEL TANK £0.55
FUEL TANK 4 oz. pressurised £0.90
BODYSHELLS McLaren F1, Hesketh F1
with rear aerofoil £2.50

EXCLUSIVE TO MODEL CRAFT

6 WHEEL TYRRELL BODYSHELL TO FIT MARDAVE 1/12 SCALE CHASSIS

Trade inquiries invited

ABS bodyshell plus instructions on how to adapt to the standard
MARDAVE Electric car chassis Price **£3.95 P & P 35p**. Trade enquiries
invited.

**MARDAVE 1/12 Scale car kit complete with Nicads, motor, etc. un-
beatable value at £37.50.**

Front Axle Beam complete with stub axles. **£1.06**
Front Wheels 25p
Front Tyres 35p
Rear Wheels 55p
Rear Tyres 70p
Speed Control Board complete with Wipers. **£2.75**
1/12 Sponsor Decals superb range **95p**



NEW

Capri RS Saloon, Vauxhall Frenza £2.00
Saloon £2.90
Lola T294 Sports with rear aerofoil and
fin plate £1.35
BODY MOUNTING TRAY KITS £0.26
Driver figure £1.95
ACCESSORIES Engine silencer £1.25
Engine heat sink (for extra cooling) £1.25
Transfers (Giant size sheet, 84 sponsors
decals + 35 numbers) £1.25
Starter wheel (4 in. dia. hard rubber for
electric starter) £1.25

STOCK CAR SPARES

Silencer £1.95
CHASSIS FRAME £5.50
FRONT SUSPENSION Complete £2.50
REAR SUSPENSION Radius arms each £0.38
Radius arms spring each £0.15
Radius arms attachment nut each £0.10
Rear axle each £0.40
1/4 in. Nyloc nut £0.05
40t Drive pulley with tube pin each £0.70

Drive belt each £0.45
FLYWHEEL/CLUTCH UNIT Complete £3.25
Clutch drum each £0.80
FUEL TANK each £0.45
WHEELS Front or rear each £0.55
TYRES each £0.55
BODYSHELLS Several types available
(Std., Coupe, Chisholm, etc.)

RADIO CRATE with attachment screws
each £1.20

PB INTERNATIONAL KIT £75.00

SPARES

Chassis Power pod £3.65
Chassis Front narrow £4.78

P.B. Heatsink head for K&B, Veco £7.50

SPECIAL

**DUSTBIN SILENCER & MANIFOLD, SIMILAR PATTERN TO P.B. FITS VECOS, FUJIS, ETC.
SENSIBLE PRICE £6.95**

SUPERSTIK contact adhesive (adjustable grade). The ideal medium for cementing tyres to wheels. The special adjustability of Superstik will allow repositioning provided that pressure has not been applied.
FUJI 19 BB R/C fantastic performance for only **£25.95** Schmueller ported, heavy duty liner, metal carb, supplied with aircraft silencer.
Veco 19 **£22.75**

CLEAR BODIES FOR 1/12

Lotus Europa **£3.79**
Porsche Saloon **£3.79**
Ford Escort **£3.79**

Trade Inquiries Invited

NEW A.B.S. 1/8 BODIES FOR 1978

F.1. Brabham BT 45 **£2.90**
F.1. Coper Sugar **£2.90**
Wing for Above **£0.75**
G.T. Shadow Incl Wing **£2.90**

ABS 1/12 BODIES

Porsche Saloon **£1.95**
G.T. Shadow **£1.95**
B.M.W. Saloon **£1.95**

King pin bush £0.36
Track rod £0.48
Aerofoil — F.1. £0.75
Aerofoil strengthening plate £0.17
Aerofoil support wire G.T. £0.34
Aerofoil support wire F.1. £0.34
Body pin front G.T. £0.30
Body pin rear G.T. — wing tube £0.40
Body pin front F.1. £0.25
Body fixing clip £0.15
Front body washer £0.15
Servo saver moulding — two parts £0.88
Servo saver spring £0.36

Ball joint moulding £0.24
Ball £0.36
Rear axle £3.50
Rear axle bearing block £0.48
Rear axle ballrace £2.18
Disc brake calliper £3.16
Disc brake cam £0.97
Disc £0.53
Disc collar £0.36
Brake lever £0.36
Brake lining £0.36
Flywheel S.T. X21 O.P.S. 3 1/2 cc £1.70
Flywheel K.B. 3 1/2 cc — Veco 19 £1.70
Crankshaft adaptor 1 ring 1/4 UNF £0.39
Crankshaft adaptor 6mm £0.39
Clutch shoe — pair £1.36
Clutch housing and gear 11t £3.00
Clutch housing and gear 12t £3.00
Clutch housing and gear 13t £3.00
Clutch shoe screw (4) £0.12
Clutch housing bearing — ballrace £2.30
Ring gear 58t £0.90
Ring gear 57t £0.90
Ring gear 56t £0.90
Engine mounting block £0.60
Radio plate £0.60
Radio plate stiffener £0.17

Radio plate buffers £0.10
Radio mounting post — front £0.48
Radio mounting post — rear £0.53
Servo bracket £0.20
Front bumper — G.T. £0.73
Front bumper — F.1. £0.60
Rear bumper £0.30
Rear hub £0.80
Front hub £0.50
Wing wire kit £1.54
Body mounting kit £2.00
Servo saver kit £23.00
Front axle kit £4.20
Track rod and ball joint kit £9.52
Disc brake kit £5.27
Flywheel and clutch kit — K.B. £11.62
Flywheel and clutch kit — S.T. X21, OPS £11.62
Engine mounting kit £1.60
Radio plate kit £4.50
Bumper kit £2.00
Fuel tank kit £2.00



R/C CARS: SWISS STYLE

LIGHT-HEARTED COMMENT BY REX WATSON

PICS BY J. C. RUMBELI

The hobby of model car racing (if you think it's a sport, try climbing the Matterhorn) began in 1972, but has grown so rapidly in the last couple of years as to be almost unmanageable. 100 competitors in 1976, 500 in 1978 means drastically different organisational requirements. In 1976 there was just one Swiss Championship, with typically 30-40 entrants to a race. In 1977 the Championship was split into 2 groups; the A group consisting of the 35 best people, and the B group the rest. Unfortunately, the first B race had 150 entries! The B group was thus hurriedly split into B and C, the B group being those who had previously competed, and the C all the rest. This did not work too well; few of the beginners were prepared to drive 200 miles (perhaps through a snowstorm on an Alpine pass) to compete. For 1978, therefore, the A group remains, doubled in size, and the rest are split into regions, followed by inter-regional races starting in July.

Swiss modellers need no introduction; the best of them make the final of the European Championship. In the lower level races, however, it is a different story. The average Swiss beginner has far more money than skill, and first-lap pile-ups which eliminate 3 or 4 cars are common. Errors at the end of an 80 yard straight

Drivers come in all sizes... don't be misled... the little chap will probably beat you!

have sent cars into the crowd. In one competition my car was rendered hors de combat on the starting line. As a result of this carnage, the experts are becoming reluctant to compete against beginners.

An interesting feature of Swiss racing is father/son combinations; daddy builds the car and acts as mechanic, junior drives. At a race in Basle last year I was somewhat disconcerted to find on each side of me on the podium an infant aged six! And both of them beat me!

At the Geneva A group race last year, all the competitors attended the dinner on the Saturday evening. In the C group races last year, however, it was a different story. Some of the races were organised by new clubs who had had little or no experience of race organisation. The fact that the Swiss speak four different languages doesn't help. At Brugg last year none of the Geneva contingent could speak German, while none of the race organisers could speak anything but German! I was thus reduced to sign language to draw the attention of the gentleman who was making the announcements that *three* competitors in one of the heats had red flags! Nobody bothers much about the rules; indeed some competitors turn up apparently unaware that there *are* rules.

Build stoutly... pile-ups are common.

At the races I attended last year the only check was on the overall length and width of the car, by means of attempting to insert the car into a wooden tray, expressly constructed for this purpose. In one race the car of the competitor just in front of me in the queue was about an inch too long to go into the tray. The official put his foot on it to try to force it in, but it wouldn't go; but he passed the car anyway. At another race 3 competitors turned up with a peculiar Japanese kit almost 6in too long. They therefore sawed 3in off the front and the back!

Sadly, it seems unlikely that this idyllic situation will last; one or two protests were registered last year, and if the ROAR rules are really applied.... Switzerland, like Britain, suffers from a lack of authorised frequencies. Only 9 are available; 5 in the 27MHz band (not including blue) and 4 in the 40MHz band. In *most* races last year someone or other complained of interference, while in one of two races, competitors were eliminated through not being able to change to an available frequency. Happily, some more 40MHz slots are soon to be made available, and it is thought that the 35MHz band will eventually be authorised. The 400MHz band is not useable due to the presence in the concrete used to make parking lots, of short lengths of metal pipes, which cause reflections. However, the Swiss Postal Authorities are always prepared to authorise the use of additional frequencies for one day only, thus permitting, for example, the holding of an annual 300 lap race in Geneva for 15

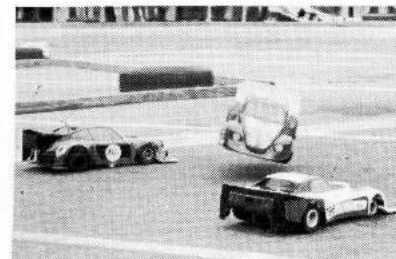

cars. It will be necessary to abandon 27MHz in due course, due to the large number of authorised walkie talkies in use. (Prospective competitors for the 1979 World Champs please note) All the gentlemen who patrol ski pistes to rescue stricken skiers carry 27MHz walkie talkies, much more powerful than 1 watt!

The Swiss model car market reflects the country's general affluence. Tuned motors are available off the shelf; at least fifteen different makes of model car are available, including several Swiss makes; Brem, Olbi, Swiss Flash, Micro Racing, all superbly engineered, at prices from £50 to £250. The Swiss Flash disc brake is the best in the world. The European Champion, Udo Franke, will sell you an UFRA, which is basically an Associated but incorporates many special parts which he makes himself, complete with tuned K&B21. You install your radio, then give the model back to him for tweaking and testing to the same standard as his winning model. Price

Continued on page 27

Swiss Postal Authorities will authorise one-day use of additional frequencies... hence 15-car turnout for 300 lap Marathon in Geneva.



STEERING GEOMETRY

CHASSIS SET-UP AND FLEXIBILITY

LAST, BUT by no means least, of the problems of steering control is chassis set-up and flexibility. In the early days of r/c model car racing the chassis was designed solidly, with front and rear springing of a fairly complicated nature. As time went on the impossibility of a simple springing practice using a rigid chassis led to changes. Today, only in the case of stock car models is a rigid chassis fully sprung in use. For its purpose of fairly slow speed operation and ability to stand up to abuse it can hardly be bettered.

What has happened to high speed model racing cars is that two apparently irreconcilable objects have been built into the chassis. A rigid rear end is needed to transfer power evenly to the driving wheels, whilst a flexible front end to carry the steering is necessary so that the car will be able to iron out unevenness of ground and sometimes erratic steering commands without departing too much from its desired direction.

This was tackled in several ways. The American practice is very largely to have a really rigid rear power pod plate (up to 3/16in. thick of aluminium) to which is bolted a lighter more flexible forward chassis plate. Some control of this flexibility is obtained via the radio (or shaker) plate which connects the two parts and provides both rigidity and flexibility to rear and front. British approach to high speed (via Keith Plested and his group of experts for PB Products) was a sandwich chassis where a long V of

Front end tune-up tips drawings. These bends capable of misalignment must be checked.

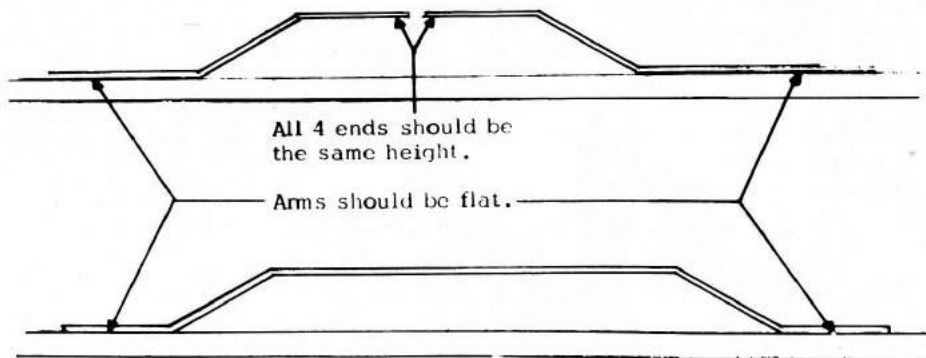

metal was adhered to a normal chassis form. This provides a tapering off from rigid double thickness at the rear to less and less at the front — a kind of metal reinforcing gusset in fact. This has worked very well and continues to be enjoyed by what can be called the middle range of expert drivers.

It still did not provide the ideal solution. This was sought by Dutch designers who tried out a fibreglass/alloy sandwich but supply and production problems prevented full exploitation. Sweden had a try with an all plastic chassis but cost of moulding presented difficulties and only produced what was virtually a "throw-away" chassis for short time use. Meanwhile Sabbatini of SG was working on a cut-and-try method of waisting a chassis hour glass fashion, good and broad at the back and slinky at the front.

This has been followed by most drivers who trim their chassis to what they think is the ideal shape. It works well but only when fitted to a given track or tracks. What suits one surface can be most disappointing elsewhere. PB Products now provide the compromise solution by offering their international kit with *two* separate chassis — one broad and one narrow, which latter can be further trimmed down to taste. A spot check on users at Lyons who had their own special widths resulted in an average difference of 1/8th of an inch, standardising at approximately three inches wide at the narrowest part. That's consensus opinion!

Whatever approach you are making to the subject it is essential that, at rest, the chassis sits squarely on its four wheels, or you will have the "wobbly table effect" of erratic running, taking a better turn on one hand than the other, and generally un-

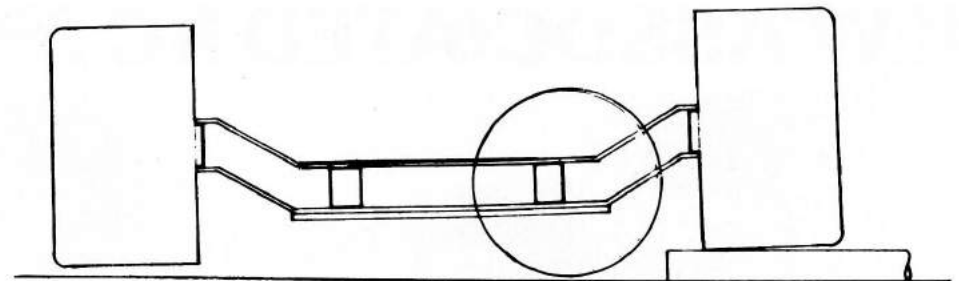

Right hand wheel comes up off the glass. Circle shows insertion of spacer shim.

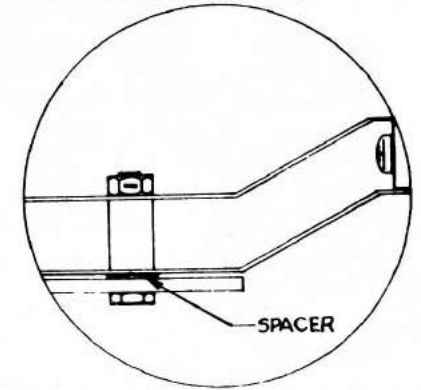

satisfactory running. A good checking surface is a sheet of plate glass. (For years I have had such a sheet with polished edges nicely rounded and used it as a surface plate — fairly cheap, easily replaced and nearly as good as the expensive metal type). If you lack this then try using a mirror laid flat on the table.

Gene Husting of Associated is very keen on this business of chassis "tweaking" and devotes part of his instruction for RC100 to it, with suitable diagrams. I cannot do better than reproduce them with extracts and due acknowledgements to the author.

"Take a piece of 3/8in. tubing and roll it under right hand front wheel. Note how far the left hand wheel comes off the glass. Do the same for the other wheel. Generally, one wheel will come higher off the glass than the other. This means chassis is "tweaked" to one side or the other. By holding the front and rear wheels, you should be able to twist or "tweak" the chassis back to square. After running the car for a few minutes it may settle back to its "tweaked" state. If this happens it will cause the car to have too much oversteer in one direction and too much understeer in the other. If this is so, instead of bending chassis back to shape put one or more washers between the chassis plate and lower cross arm, as shown. Place only as many washers as it needs to get the wheels to come off the ground the same amount left and right with the tubing test."

Needless to say, the two rear tyres should be of same diameter as each other, and the front tyres ditto. The normal equal bends and flat surfaces of the front wishbones should also be above suspicion. As machine cut and jig bent items they may not always be absolutely true and should be carefully checked as the first suspected culprits of irregular running.

SWISS STYLE from page 25

£500. He will also sell you tyres which, when fitted to my car, reduced my lap time from 14 to 12 seconds.

Associated have the largest share of the Swiss market due to the fact that this year's spare parts fit last year's car (other manufacturers please note).

In Switzerland, there is no disused land, and as a result there is only one permanent circuit, near Locarno. All other races take place on parking lots, using lengths of wood 10ft by 4in by 4in to mark out the course. The average Swiss race thus starts at 6a.m. with the construction of the course (you guessed it, by the same dedicated few). Races always last 2 days; formula on Saturday, Sport/GT on Sunday. For 1978, there are races every weekend from mid-February (if necessary, the race will start with the clearance of snow from the course) to November. The Zurich club recently published an offer to pay £125 to anyone who could find a suitable piece of land they could buy!

The Swiss are concerned about the 1978 rules which seem designed to facilitate the holding of a biannual race rather than to reflect the wishes of the majority.

NEW ASSOCIATED RC 200 KIT

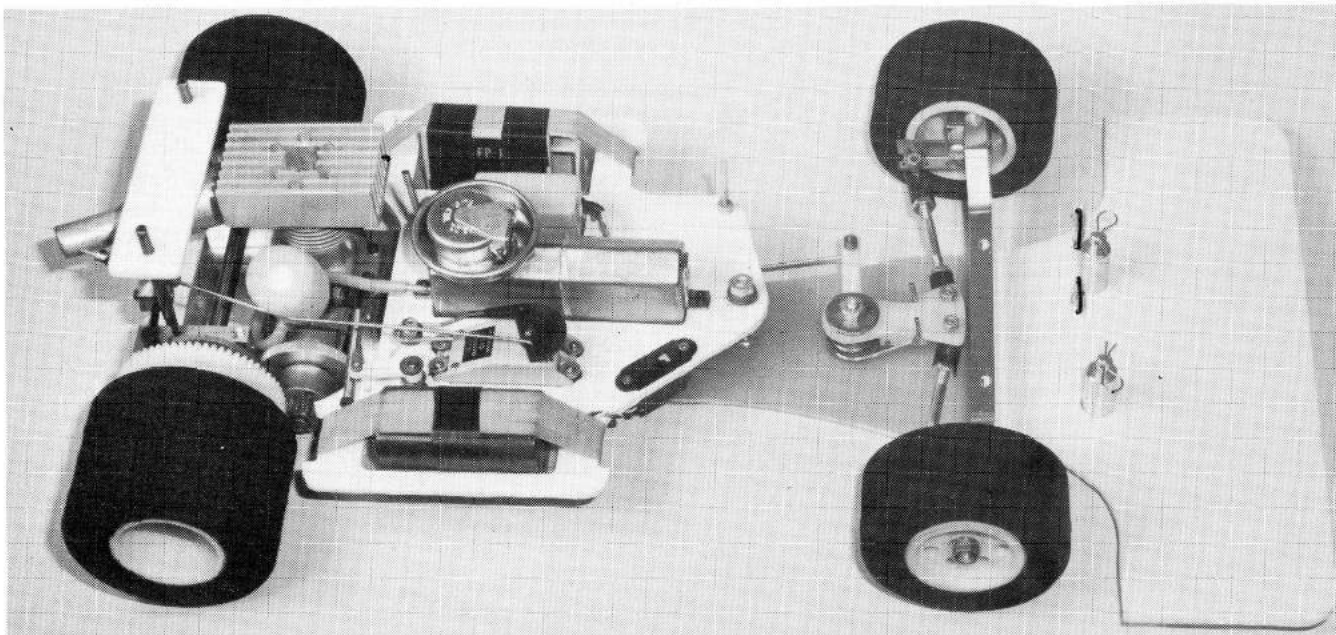

NEW FEATURES

Aluminium Front End
 New Servo Saver
 Ball Joint Tie Rod
 Fibreglass Chassis
 Disc Brake
 8mm Rear Axle
 New Rear Pod Plate
 New Gear Material
 Plus Fuel Tank

PROTOTYPE RC200 CARS WERE USED BY WORLD CHAMPION, BUTCH KROELLS, AS WELL AS THE FIRST 7 PLACE FINISHERS AT THE WORLD CHAMPIONSHIPS.

1977 EUROPEAN CHAMPIONSHIPS



PER GUSTAFSSON — SWEDEN
 SPORTS CHAMPION



UDO FRANKE SWITZERLAND
 FORMULA CHAMPION

1977 USA ROAR NATIONALS

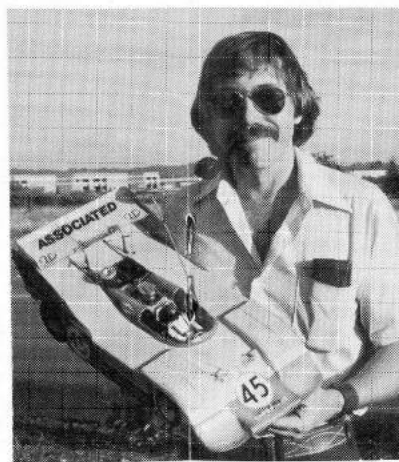

ROGER CURTIS
 SPORTS CHAMPION



BILL JIANAS
 G.T. CHAMPION

SO. CALIF SERIES

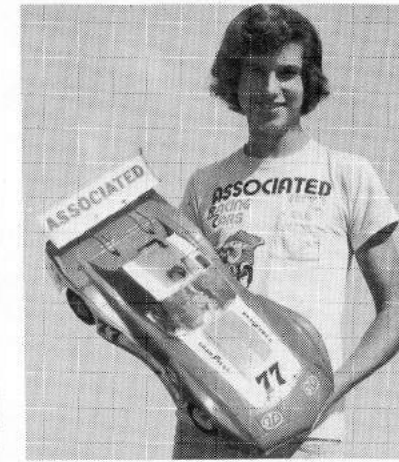

CURTIS HUSTING
 WINS FINAL 2 SO CALIF
 SERIES RACES & 1977
 ENDURO RACE

ASSOCIATED 1928 East Edinger, Santa Ana, CA. 92705, USA

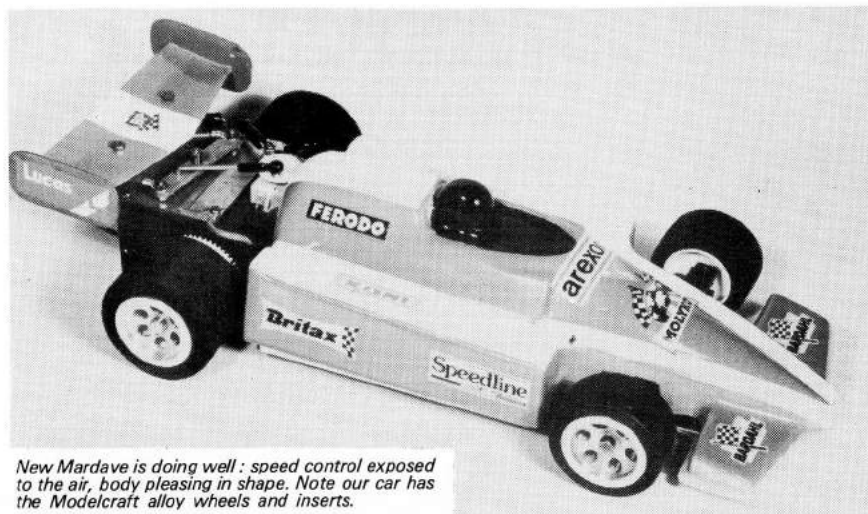

New Mardave is doing well: speed control exposed to the air, body pleasing in shape. Note our car has the Modelcraft alloy wheels and inserts.

BRITISH ELECTRICS

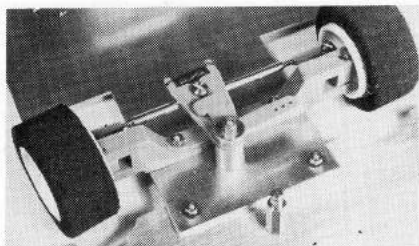

How they steer. Above Lectricar (note mounting for new body). Below: Mardave side slung nicads help weight distribution.

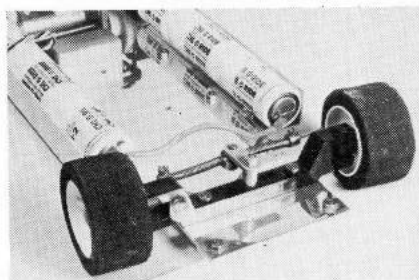

After nearly a year's solus run, Lectricar have been joined in the electric r/c model car market by Mardave offering a completely different approach to the subject. When Dave Bailey and Steve Talbot joined forces to manufacture the Lectricar they decided to produce a unit that could not be faulted for quality with price — in a field then unestablished — as a secondary consideration. This search for perfection extended even to the large round head screws used, all made in the factory. Wes Raynor tackled the problem from a strictly Mardave angle. Mardave have been making their racing cars and stock cars from the establishment of the hobby in this country at rock bottom prices, and this was the course to be followed with the new product.

In this the company has succeeded magnificently with a kit retailing at £37.50, complete with body, motor, all necessary parts, nicads, requiring only servos and r/c gear to complete. The same specification, of course, is followed by Lectricar though at an appreciably higher price. Let us be quite firm, however, on this matter of price, frankly I don't know how Mardave do it! I accept that the Lectricar price is also remarkably low for the quality of the product. Coming in later Mardave may have had the advantage of bypassing some production problems that cost money, but they always intended to have a price "under £40". The two rival kits will doubtless continue side by side, the lighter Mardave with slightly less purpose built parts, and the benefit of larger Mardave

The speed controls: Above: Lectricar. Note also new rear bumper. Below: Mardave with servo built into plate. (Linkages not fitted for clarity).

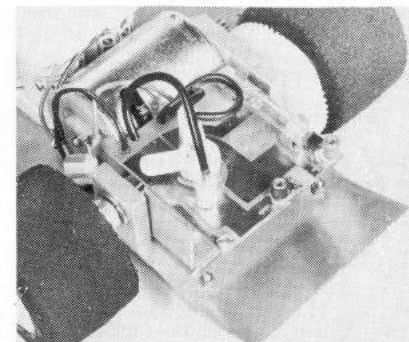

cars to effect economies in material purchases, plus the opportunity to use up a higher proportion of the sheet rubber out of which tyres are stamped. For racing enthusiasts this lighter weight may account for their present run of success at meetings (without detracting anything from drivers' skill, please).

THE KITS SIDE BY SIDE

This is very much a personal preference game, but we can look at the two kits and consider in what ways they differ. Lectricar started with a fairly expensive micro-switch speed control system which was not entirely satisfactory on highly polished floors, as racers at Alexandra Palace and elsewhere soon found out, though excellent for rough wood or school playground surfaces. The switch to a printed circuit panel to provide proportional control was a logical move. This type of control which is really an improved form of rheostat control still generates heat, but not all that much now that special heat sink types of printed circuit board have become available. Mardave from the start has been developed with printed panel proportional control in mind as a simple, relatively in-

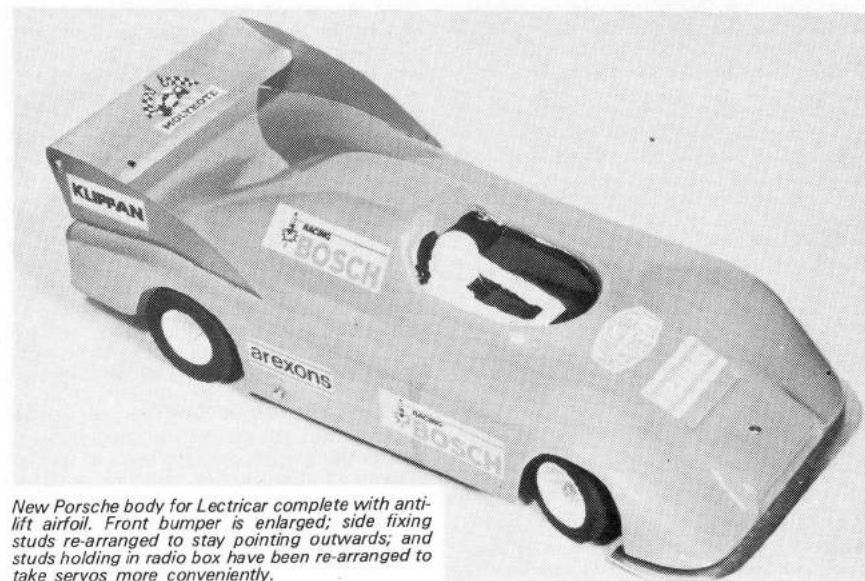
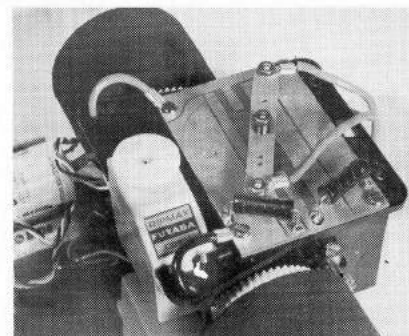

New Porsche body for Lectricar complete with anti-lift airfoil. Front bumper is enlarged; side fixing studs re-arranged to stay pointing outwards; and studs holding in radio box have been re-arranged to take servos more conveniently.

expensive method. The expensive transistorised "black boxes" on offer are the ultimate answer but costly, and require near duplication of parts to provide reverse.

Throughout last summer the Mardave test team has been running cars with minor variation after variation to get the simplest possible reliable control. All the usual problems of overload and burning out of panels by sparking have been encountered and cured. A truly frustrating period this must have been for Wes, with thousands of motors and stacks of parts all ready to go, but held back until he was quite certain it was as near foolproof as it could be.

First major difference between the kits is the location of the nicads. Lectricar put theirs in a neat stack, boxed and unobtrusive in the rear centre of the chassis base plate. Round them goes the U-shaped box holding the radio gear. Mardave preferred to put theirs in two sausage strings, one each side of the chassis length, where on a fullsize car the petrol tanks would go. Less neat and tidy, but theoretically the better place for weight distribution. It also encourages use of a low slung body with cells lying flat instead of upright.

Steering systems also differ. Lectricar have the clever springloaded tong system, first seen on model cars in America. Mardave have adopted a smaller version of that used on some of their stock cars, with straight in-line springing, which probably achieves some production saving. The early Lectricars had a slight design fault in that cars could be rammed from the rear to damage the control plate. This is now altered with a stout alloy plate bent up to protect this vulnerable part. Mardave have theirs poised well over the engine mounting and out of harm's way. In their instructions (mine are original first 200 test run words) it is necessary to cut into the plastic plate holding the control panel to take the steering servo. This is perhaps a pity if several cars are being run from time to time and only limited servos available. I

Another painting job for Mardave (we suspect Stewart Busby!) Done in dark blue and white - very effective.

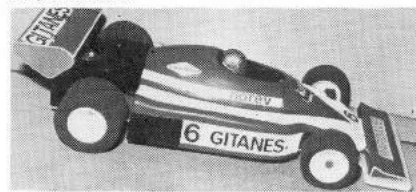

have just seen a Greeno treatment that appeals, where servo is not so attached. The plastic bracket for aerial webbing and holding receiver on/off switch is slightly cut away to allow servo (Futaba 16) to stand upright. Usual largish Futaba nicad is not used, but the smaller half power job (as offered by several other manufacturers) which is almost square only takes half the space and so permits this.

Lectricar have now added a Porsche 936 to their range of bodies (Ford Escort, Porsche "Street") and provide hexagonal pillar fixing like the "big" model cars. Mardave delight me by using Velcro tape for attaching bodies. I am now using it extensively from fixing loose covers to the furniture at home to sensible model uses like this. It is quite secure enough for use in this scale if a bit hazardous with 1/4th (but we shall see).

Mardave have the pretty Turbo Porsche 935 body as their saloon offering, and the less popular BRM Formula body. I have also just seen a couple of other non-standard bodies that can be fitted, and a modification to convert to a six-wheel Tyrrell. There will be a spate of bodies for both kits in the months to come.

THE COMING CRAZE

Dan Rutherford in a lead article of this title in the U.S. magazine **Model Retailer** tells of the beginning of an Electric R/C Car Pay Circuit, where you buy time and use the "house" cars and radio equipment. It is sophisticated enough and stout enough for this to be possible even with unskilled operators! Run in conjunction with a model shop it not only pays its way as a track, but also promotes additional shops sales. This is encouraging in one way; alarming in another. As the author points out, no American trader can see this prospect without harking back to the slot-car pay tracks of the sixties and the collapse of that market. This was due as much as anything "to enthusiasts buying up the goodies" to quote the author, "just to keep competitive, plus not being far-sighted enough to realise that they were fast getting to the point where nobody could afford to compete." This same thing killed cable racing in the U.K., when speed enough to win was too dear to buy.

The answer must be in the hands of national race sanctioning bodies, perhaps by arranging appropriate groups to give all classes of drivers and equipment a fair crack of the whip. This looks like the present pattern as developing with electrics... let us all be careful not to fall into the trap of "I can afford a faster car than thou!"

IRVINE  **SANWA**

PORSCHE 935 TURBO

ELECTRIC R/C CAR



£59.95

This superb new battery powered model from Sanwa incorporates a 2 channel R/C System for proportional steering and speed control. Chassis and radio unit supplied, assembled, ready to operate. Radio unit may be removed for use in other models.

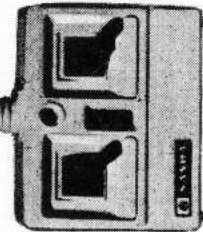

UNIT 8, ALSTON WORKS, ALSTON ROAD, HIGH BARNET, HERTS. Tel: 01-440 0923.

IRVINE ENGINES



NEW FROM NUREMBERG

R/C cars were the year's Toy Fair sensation! German model firm leaders Graupner have entered the field with both glow & electric: many others great and small are climbing on the bandwagon . . . Some will fall off again perhaps . . . Here we offer a first taste of things to come . . .

Model Car Vertrieb offer a sophisticated range supported by leading German drivers. Splendid front axle arrangements, spring loaded filler to fuel tank, drum and disc brake options. Engineer produced.

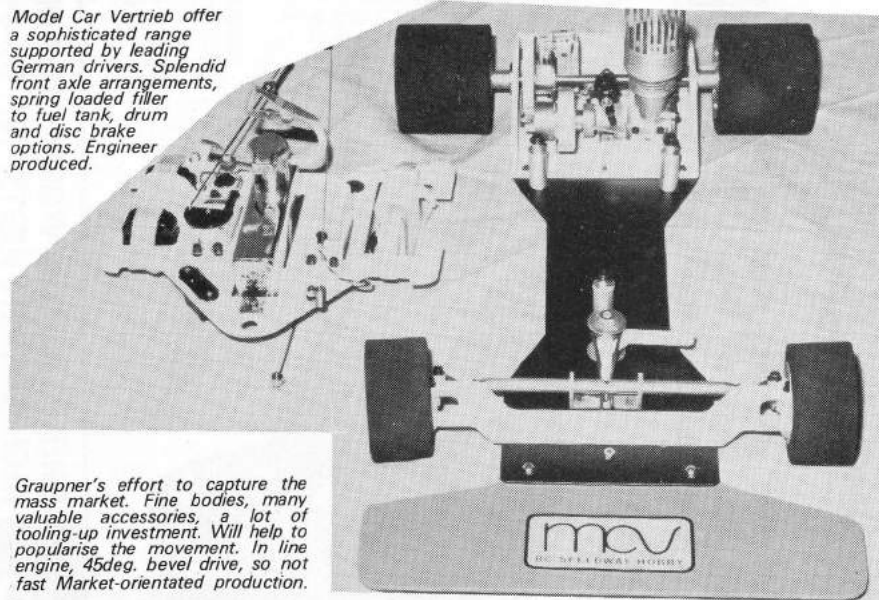

Graupner's effort to capture the mass market. Fine bodies, many valuable accessories, a lot of tooling-up investment. Will help to popularise the movement. In line engine, 45deg. bevel drive, so not fast Market-orientated production.

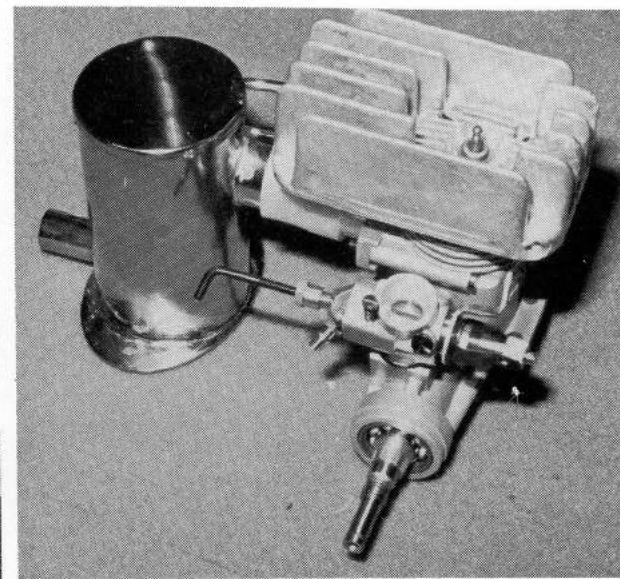

Super Tigre, now with dustbin type silencer on mounting lugs, and other minor improvements. A new and revolutionary engine is expected in a month or two but not yet unwrapped. Meanwhile, the SG outfit has produced (not illustrated) a great new design with many mods., including much improved Ackerman by moving the stub axles, radio plate, in fact all the things learned during the season in Europe and U.S.A.

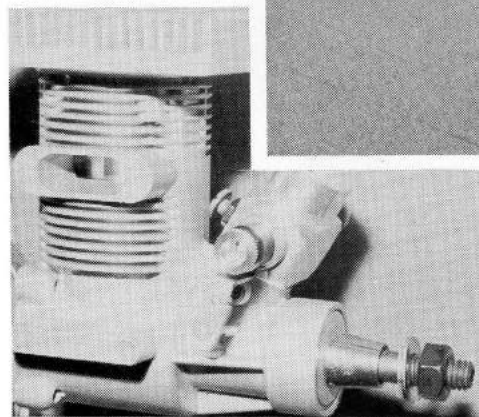

Not wildly exciting perhaps, but the tip of a new iceberg - this is the Webra 20 RCA specially developed for cars. Capacity 3.42cc, bore 16.5mm, stroke 16mm, or nearly square, double ball bearing. Silencer and heat sink available. This has been tied to the Challenger chariot, and they will be working with Per Gustafsson to perfect it.

My own favourite (of many to be seen) bodyshell, featuring the turbo Renault as raced (a little) by Jabouille last season. An offering from Turin's Model Car of Italy. Not very impressive kit, but some nice bodies and a lovely range of transfers.

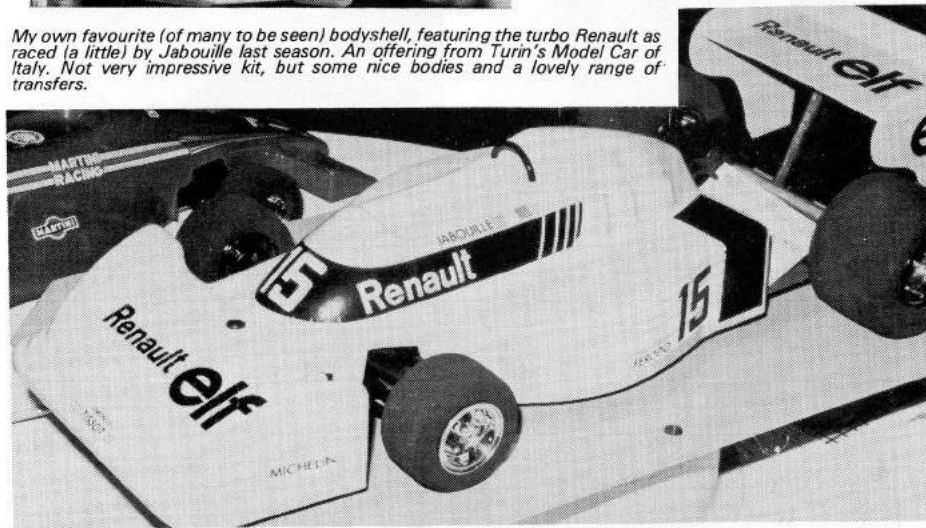

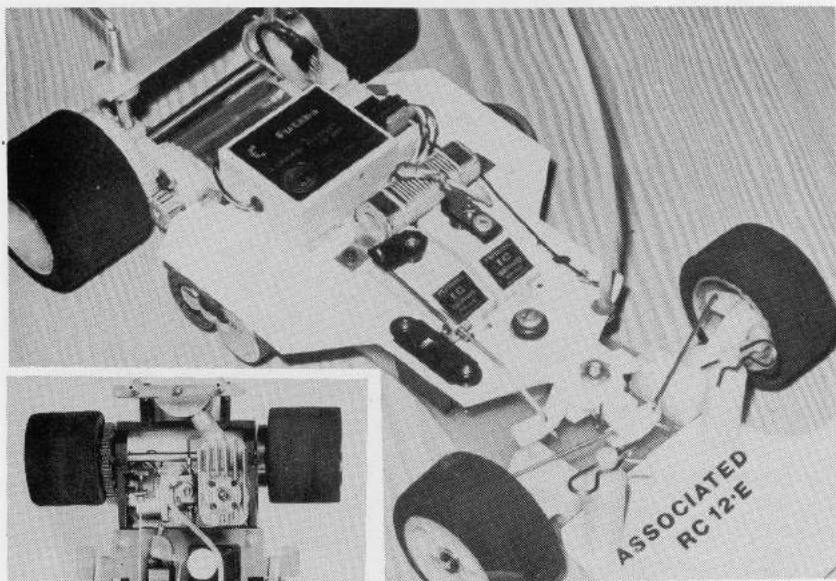

Top: Associated's 1/12th scale electric — still too busy on i.c. to produce.

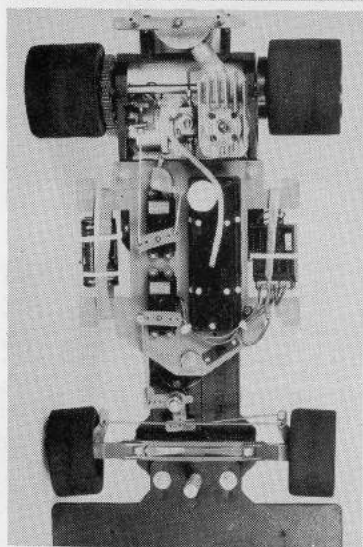

Left: "Medium level" Challenger ready for 1978—more advanced design has disc brakes and black anodised heatsink (pretty but why?).

Below: Body hides Bob Rule's even better Bo-Link with all own components — success of current model is delaying its release.

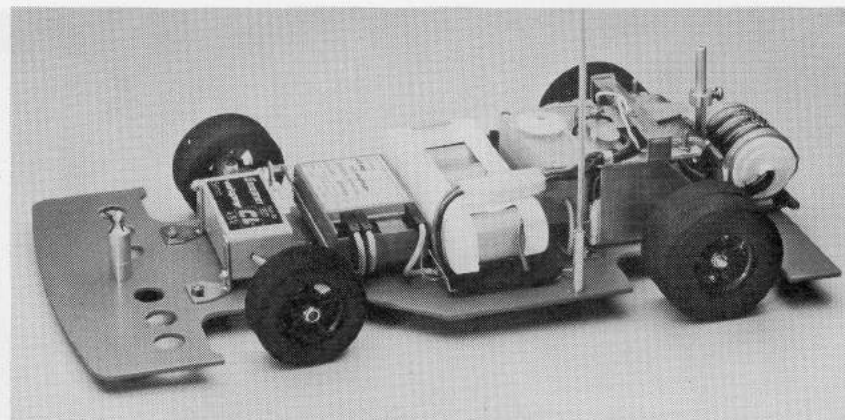
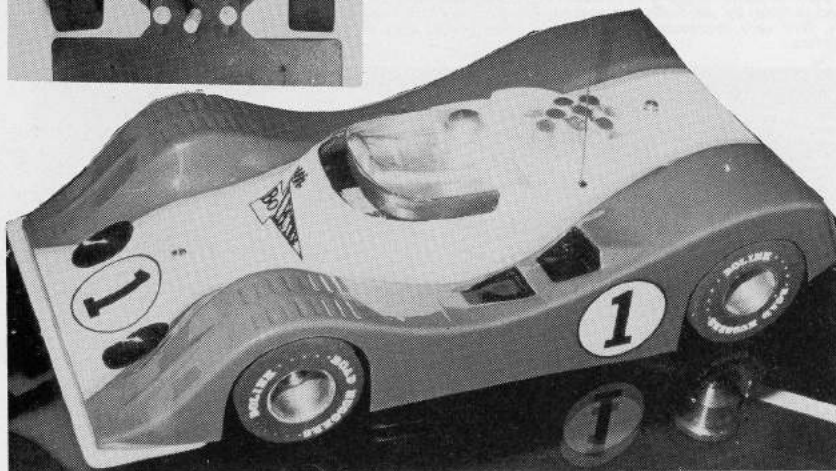

Above: Neat Graupner 1/12 electric. Note Nicads at back. A winner!

Left: Worm-drive (7.5 to 1) on a Micar with in line motor. Sprung rear (and front) end.

Minicars Challenger disc brake arrangement. Neat as everthing else from the Per G. stable.

Left centre: Another Micar shot. Note U-section chassis; neat extension piece to carry smaller gear.

Very robust.

Bottom: The music comes out here! Longest exhaust pipe in the business from the Graupner production car.

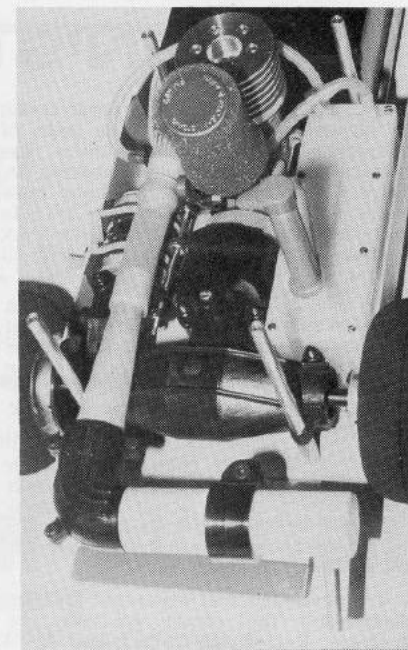
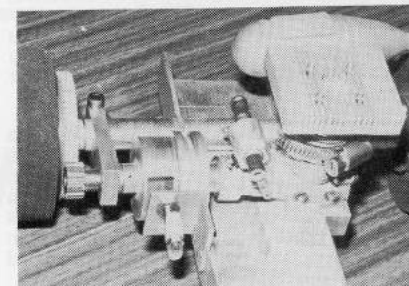
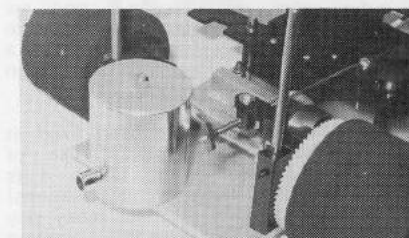
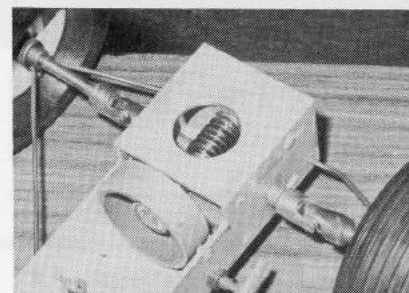

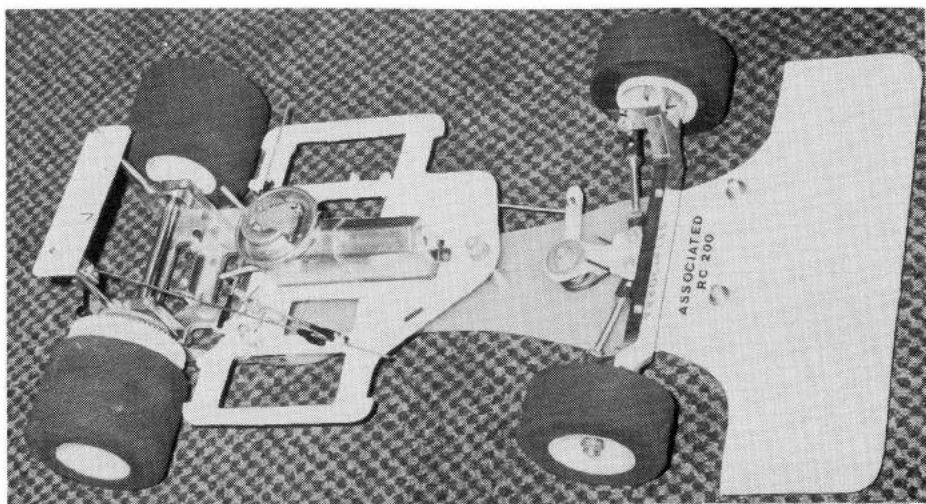

The Associated RC200 a much refined development of all the cars that have gone before. Likely to have as many wins as any and undoubtedly a cracking average of "still running" at end of every race.

This is just a small selection. As cars come on the market during the year we shall be following up with full reports and expert opinions.



LONDON'S OWN.....

YES, London has acquired an urban circuit of its own at last! After many years of struggling, turning down various less suitable site offers, and just pressing on, Dave Rogers and his faithful band have made it! The London Radio Car Club is in being and will be running at the Eaton Park Raceway, Quarter Mile Lane, Leyton E.10 by the time this appears.

An already existing large asphalt area provides space for a lap length of at least 300 metres (largest in the world?); there is a covered rostrum, room for up to fifteen people, and all the desired facilities, including toilets and showers — yes, showers.

Four or five trial circuits have been chalked out; final one will be lined out with road marking paint (about ½in. high) which will help to keep cars from leaving the track without putting them too much off their line.

It is envisaged that restaurant facilities overlooking the circuit will also be available. Racing will take place every

Sunday, plus six Saturdays and six Wednesdays in the year. One club race meeting a month is being fixed, plus a possible club challenge meeting. No Open Event is scheduled for 1978.

Membership Fees have been fixed at £15 per annum (to include use of Bovingdon Airfield circuit which it is hoped to retain after further negotiations) Members living over 60 miles away pay £7.50. Students and those still attending full time education £5: all plus £1 entrance. To learn more contact: Phil Greeno 01-866-7770; Bob Rosser 01-864-7313; Dave Rogers 01-804-0928 or 1183. Membership will be limited to about seventy. More next issue.

Location: Off Ruckholt Road which runs across Hackney Marshes. From the South via Blackwall Tunnel proceed up A102 to Hackney Marshes. Quarter Mile Lane is on right adjoining Leyton Orient Football Ground. From North by A112 to Leyton High Road, turn right into Ruckholt Road and Quarter Mile Lane on the left.



WE ARE

COMING

**THE
GERMAN
TURBO — PANZER**

fine worked RC — Racecars!

Première: Toy Fair 1978 Nuremberg

MODELL — CAR — VERTRIEB

Postfach 12

D — 6842 Buerstadt/West-Germany



LITTLE BIG CAR (1/12 GLOW) SG

Servos, nicad and Rx set-out with ball-connected steering (not standard). Until we get, or make up, a suitable heatsink and silencer, alas we cannot actually run this attractive little beauty.

FRANCO SABATTINI has broken new ground in introducing the first European made 1/12th scale glowplug engine car kit under the SG banner. It is indeed a scaled down version of a 1/8th scale car with a one piece clear Lexan chassis that embraces not only the main chassis base but also the front bumper and rear platform on which the fuel tank rests. Unlike nearly all American built 1/12th cars it owes nothing to the almost universal Jerobee chassis (nothing against Jerobee — it is a beautiful little chassis and carries my Electro Craft Systems unit quite splendidly, but it is nice to find a bit of original thought!)

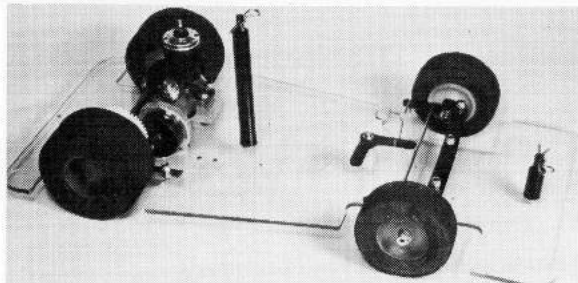

The car with its clear Lexan chassis as provided almost RTR in custom-made polystyrene box with 16-page "how-to" booklet (in Italian).

In common with the larger SG kits it is presented in semi-assembled form, and, marvel of marvels, comes with a 16-page instruction leaflet in Italian. Line drawings are usefully explanatory, many of the excellent photographs have filled in as dense black, thanks to the printing process. But even without any Italian enough meat can be abstracted to make completion fairly simple.

Power unit is the little Cipolla engine, installed in place, complete with glowplug, and with flywheel, bellhousing and clutch fitted. No heatsink is supplied, though listed as an accessory. Nor is there a silencer (this does not even seem to be

listed — perhaps noise level is low enough to dispense with one — but I doubt it). Fuel tank is a small plastic bottle provided with suitable screw in fittings for vent, fuel line, and filler. This unit goes behind the engine secured with a wrap over strap and two bolts and nuts. Included in price and part of the kit is either a Formula or GT bodyshell. I opted for the Formula body, wing of which is integral.

Tyres require to be glued onto wheel hubs in the usual way with contact adhesive, Evostik or Dunlop, and seem a little narrow for the hubs provided, so should be fitted carefully, coming to the outside hub edge to give widest overall width. Track rod is already fitted, as is steering arm from centrally placed bellcrank. This installed is straight; instructions show it with a loop to take shock of over-riding from the servo.

This layout, to my mind, takes up more space than is desirable, so I have followed my Jerobee (can't get away from that Jerobee!) steering layout, with servo connected directly via swivel links which part company with their ball in event of severe shock. By omitting bell crank there is plenty of room for the larger and stouter Futaba 17M which I have. In this scale very nearly any of the less expensive servos could equally well be fitted and should stand up to reasonably hard usage.

At the rear engine control and braking is taken care of with a 16M Futaba servo — again any of the smaller jobs can be used equally well. Brake is a push-on type of quarter quadrant, lined with a little sheet rubber, so that servo pushes against the

spring of the metal which is bolted down on the chassis. I think it is a bit severe so am easing tension a little by bending back and reducing the area of lining in contact with the bellhousing.

Receiver is located in front of the steering unit and just fits in behind the front body mounting job, which gives it some protection. Battery can be fixed on the opposite side to servo for engine and brake — though it may tend to load that side of the car, so get it well back and as close to rear body mounting post as possible. Lexan chassis has recesses for rubber bands to hold in place, as also for the receiver.

All that remains is to fit the Rx on/off switch conveniently and rig up the aerial. I am a little disenchanting by the small cars with aerial threaded like darning inside bodyshell, so have a small whip, with easy plug in connection to Rx so that moving from car to car is as simple as possible. With Lexan chassis aerial fixing offers no problems.

Another notable omission is the absence of a filter. The Cipolla engine does not lend itself very well to a mechanical installation, so that a plastic foam type seems the only quick answer. If and when this size of car becomes popular there will be a spate of suitable accessories for them.

I see that it is advertised in some French model mags in an alternative electric powered version, maybe I'll convert whilst waiting for the other bits! Meanwhile, here it is, very nearly complete and selling at around £55 . . . what it will be in native Italy or elsewhere in Europe I do not know.

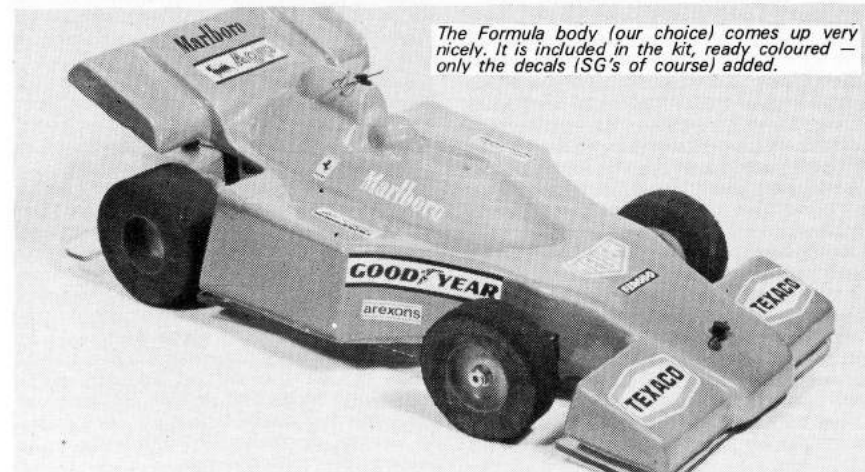

The Formula body (our choice) comes up very nicely. It is included in the kit, ready coloured — only the decals (SG's of course) added.

STOCK CAR NOTES

COMPILED BY PETER "CRASHER" CRAWLEY

HOW TO GET A RED ROOF

This is not a very difficult thing to do as all Stock Cars are much the same, as there are no engine modifications allowed for a start, i.e. fancy tuned heads, ally pistons, etc.

So all drivers start a race with equal chance, due to the grading systems in use, these do vary in clubs all over the country, I am not sure if I am right in saying that the club I belong to use a very tough grading system, which really does make the top grade drivers use all their skills in a race meeting. For those interested this is how it works. A White Top driver (novice grade) starts a race with a 3 lap start. A Yellow Top driver starts a race with a 2 lap start. A Blue Grade driver will start a race with a 1 lap start. Thus leaving the Star Grade drivers (Red Top) with a 0 lap start. Thus calling for a great deal of skill from these Top Grade drivers. Now all the Red Grade drivers are shouting "You can't win with this kind of handicap". Well you're wrong as I have done it many times, and a lot of our novices have won races also. A lot of drivers own some very fast cars but just don't know how to handle them, because instead of starting to drive their cars slowly to get the feel of them, they take off like bats out of hell trying to keep up with the top grade drivers, resulting in nothing but a pain in the neck, causing all the other drivers costly repairs.

HOW CAN I IMPROVE MY DRIVING SKILLS

This is done very easily with the use of some light objects and a small area with a hard surface, the idea is to place these objects all over the surface and drive your car round and in between them, (slowly at first) this way you will learn how to avoid collisions with other drivers in an actual race meeting, resulting in an almost clear run round the track without too many crunches.

Remember speed does not always win a race but skill does.

Once you have mastered the driving skill at a low speed, then you are ready for a few faster runs, this is where the track will help, here is a target for you to beat, drive your car round a circuit with two 30 foot straits with an 8 foot radius at each end. If you can complete a lap in 5.2 seconds then you are not far off the point of being a red roof driver.

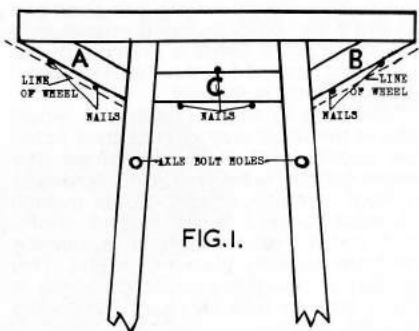

PROTECTING THE FRONT END

This must be done if you want your car to last for some time, the front bumper on a Mardave will require some additional strength in the form of extra metal, the metal used in the construction of a chassis can be purchased from any engineer suppliers at a very small cost. The name given to this metal is $\frac{1}{2}$ " square steel tubing 16 s.w.g. black... For the front end modification you will only need about 6 inches. You will also need a good friend with welding equipment, or if not do it with silver solder, the latter not being very strong.

First of all the front of the car should be stripped and attached to a wooden board, the position of the front wheels should be marked on the board as if on full lock in either direction.

Take the metal and cut two pieces and file to shape to fit as shown in fig. 1, these being parts A and B. Cut another piece and again file to shape to fit in between the two side members, this being part C... The pieces that have been formed can be held in position by small nails. Once all the joints have been spot welded, the car can be removed from the board, thus allowing all the joints to be welded. Whilst you have the use of welding equipment I suggest that you remove the nuts which hold the front override bar in place and weld in place, this looking more like the real thing. Clean off all the carbon deposits from around the welds and repaint. Replace the front axle and check that the front wheels do not get obstructed by the metal supporting the front bumper.

STOPPING THE DRIVE BELT FROM COMING OFF

This can be done very easily with the use of a piece of plastic card, the thickness of the card should be about $\frac{1}{16}$ inch to $\frac{3}{32}$ inch.

Cut a disc of plastic to the same diameter as the cog and drive belt, drill two small holes in the disc and the drive cog, these being to hold the disc in place. A larger hole will be required in the centre of the disc, this being the same size as the rear axle, two small self tapping screws will be required to hold the disc to the cog. The disc should be fitted to the rear side of the car (rear side is the left hand side looking at the car from the rear) see fig. 2.

THE REAL THING

May I suggest that those of you who have not yet seen a fullsize Stock Car race meeting do so, for you will get a much better idea of how a Stock Car should look. Also don't cover a car with a load of transfers, because a fullsize car just has a few. Finally don't copy another person's car for design and colour because you'll end up driving the other persons as was stated in issue No. 2.

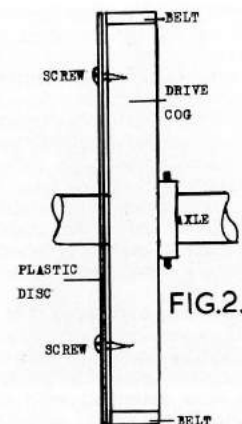

NEXT ISSUE

I will be covering the following Modifications:-
How to improve the rear suspension of a Mk 1 Ke'Jon Stock Car. A report on the Sussex Championships.

RADIO STOCK CAR ASSOCIATION

In the absence of retiring chairman Bob Webb, Dave Wragg took the chair before an attendance of over forty members at the AGM held at the Association's Headquarters at Mencap School, Western Park, Leicester on Sunday December 11th. First business was a review of the season's activities, when Competition Secretary John Orton reported regular meetings held at Coventry, Newbridge, Mencap and Bachelor Bowles to a total of sixteen in all. At these meetings seventeen drivers took points towards the Seabrook Trophy, won by Dave Wragg with Steve Talbot runner up. Other meetings included Sandown Park and Chessington, and the World Championship meeting already reported. A meeting at Mencap resulted in some £37 taken on behalf of the mentally handicapped children at the Mencap School. Attendances had also been made at the Dutch Championship.

Officers for the 1978 season were then elected. Chairman Stewart Busby; Secretary John Orton; Treasurer Dave Wragg. Committee: Leicester Rep: Steve

Talbot; Coventry: Steve Holmes; Chessington: Roger Bye; Keighley: Peter Humphrey.

The meeting next discussed possible amendments to the rules and constitution. These will continue very much as before, except that the allowable cost of a stock car is raised to £35, being a fair upgrading as at December 1977. This would be subject to annual upgrading, as might be necessary. To this could be added engine cost, based on Veco plus Kavan carb, and was fixed at £35, again subject to annual revision.

Vexed question of grading produced a lively discussion. It was felt from the chair that Association's finances did not justify possible expense of a central grading system, so that it should continue to based on local grading. Some thought was given to limiting number of Red and Blue drivers with unlimited numbers of yellow and white tops. Ultimately it was agreed that a sub committee deal with this subject. A similar committee would also sort out the season's fixture list to ensure a minimum

of date clashing. Entry fees for events in 1978 would be 70p for members over 16, up to 16 years charge would be 50p.

Cost of producing a Newsletter raised some questions, but Mardave's Wes Raynor offered to arrange its duplication in his offices, so that only expense would be postage, and this might be reduced by sending out bulk packets to clubs. Possibility of group insurance for members was considered, particularly if this could be incorporated in an all-in annual subscription. Again this was a committee matter to discuss.

Some regret was expressed that in spite of the rapid expansion of the movement, the association tended to be regarded as a locally oriented Leicester group. This image was now widening with clubs at Coventry and Chessington and Keighley. The strong Haywards Heath club was not, however, affiliated, mainly because of differences of opinion on the subject of grading. If this obstacle could be overcome they would be a welcome addition to the strength.

On an international level there was every expectation of even more co-operation with the lively Dutch group, particularly as the latter had now decided to abandon their roll over bars which was the main point of difference between them and British cars.

By the 1979 season at least one other purpose built track should be in being at Narborough, on the A46. Planning consent is being sought and a tarmac oval will be laid. Here the Keighley Club were help-

ful with cost figures of materials.

The meeting concluded with a series of films of fullsize stock car racing and model car racing, organised by Dave Wragg and others.

Where the Tracks are:

MENCAP lies at the entrance to Western Park on the Hinckley Road (south) into Leicester. This is the RSCA track and does not have a club attached.

BATCHELOR BOWLES is another Leicester circuit, situated on the premises of the engineering firm of that name in Freeman Common Road, Leicester, near the Cattle Market.

NEWBRIDGE is the first purpose built circuit in the U.K., built by Wes Raynor of Mardave, and lies in a former railway cutting at the junction of B5380 road from Desford to Kirby Muxloe with the road going up to Ratby and Groby. These are all villages to the east of Leicester.

KEIGHLEY has a track at Marley in the grounds of the Keighley & District M.E.S., of which the Stock Car Section is a part. **CHESSINGTON** have the use of a car park circuit on most Sundays at the RAF Rehabilitation Centre at Chessington.

HAYWARDS HEATH have Sunday use of a car park.

Since layout of a Stock Car Circuit is simple many new clubs may well be springing up on week-end car park sites which have not been reported to us. News will be very welcome, as so much correspondence ends with the please where is my nearest track, club etc...

racers. Time-keeping equipment built by Phil Arnold and John Lammiman is on loan from the Coventry Stock Car Club until there is enough in the club kitty for these two experts to build another one.

After the first round of heats, Geoff Labbett and Dave Preston were in the lead with 28 laps; five others being 27 laps. Next round heats Wes Raynor clocked 29 laps to catch Geoff with total of 56. All these with Mardaves. Heat by heat drivers were increasing their laps as they learned the circuit. However, last heat at Wolvey is run in reverse direction with no practice allowed (though early birds *do* sneak a quick lap or two). Wes Raynor headed the field with 114 laps, and then a fine 30 laps to finish. Des Norton (Mardave F1) and Dave Wragg (a beautifully painted Porsche Lectricar) both overhauled Geoff

Right: Pit corner at Countesthorpe. Theatre type banked seats for spectators and a splendid buffet.

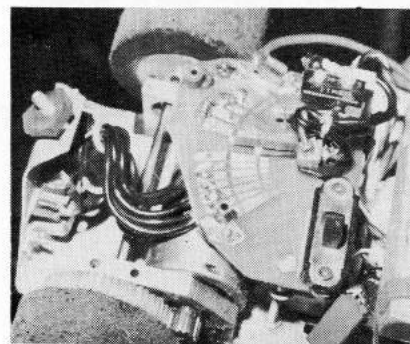

Above: One of many novelties — this by David Andrews of Leicester — is a sweep type speed control. Note also siliconed tyres for better adhesion.

Labbett in this last heat to take 2nd and 3rd places overall, when Geoff found he hadn't enough steering lock for reverse direction! Wes Raynor should have felt over the moon at this after all his development.

Result: 1. Wes Raynor (Mardave) 144 laps. 2. Des Norton (Mardave) 140 laps. 3. Dave Wragg (Lectricar) 139 laps.

Round 2. Lectricars first taste of Countesthorpe 28th Nov. 77

Next round was at Countesthorpe College, and most Lectricar drivers were here for first time to find a very different floor surface, though about the same size of circuit. After the rough wood of Wolvey the polished wood at the college needs extra care. Several drivers were trying out mods, with caps, and with liquid silicone liberally applied on front and rear tyres and allowed to set. Drivers have also been experimenting with speed controllers, ranging from little "black boxes" to coils of resistance wire looking like mini-electric fires, and some even glow like them! They all seem to work, though not all have reverse which is one of the main advantages of electric cars.

Eighteen drivers lined up for the

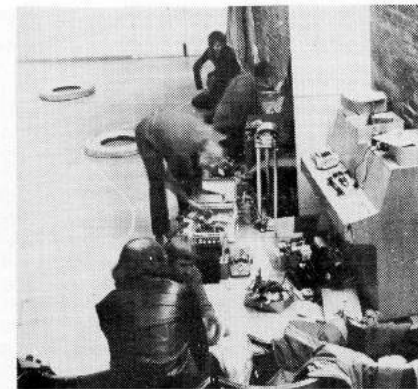

evening's racing; all drivers getting four five-minute races. Des Norton led the field with his Mardave F1 at 26 laps with four others on 25 laps. Another 26 laps in heat 2, kept him ahead, with Wes Raynor and Steve Talbot on 49. Third and final heats saw no change leaving Des on 102 laps, Steve Talbot 2nd on 99; Dave Andrews (with his own scratch built car) 3rd on 96 laps.

STOP PRESS

Wolvey 15th Dec. Bad luck for Steve Talbot.

Steve Talbot with his Lectricar Escort seemed to have this round in the bag with some good consistent driving, until during the last heat one of his front tray bolts sheared and allowed tray to foul steering. This let in Wes Raynor, who was never far behind to take first place, with second place going to club secretary Dave Davenport.

Countesthorpe 19th Dec. 1-2-3 for Mardaves

With most drivers having cottoned on to the use of silicone treated tyres at the college, this meeting produced some good close racing and also saw a fair number of newcomers trying their hands. Geoff Labbett took first place with his Mardave Porsche; Wes Raynor second and Des Norton 3rd with Mardaves. This was first victory for a saloon bodied car in the championship, and also the first Mardave 1-2-3.

WEST GERMANY & AUSTRIA (BITTE BEACHTEN: BRD und ÖSTERREICH)

With this No. 4 Issue I am happy to announce that M. A. BLOSS, Postfach 1228, 4790 Paderborn will be handling the magazine in West Germany and Austria, and all enquiries either TRADE or SUBSCRIPTION should be so addressed. With copies so distributed will be included a summary of the contents in German, so that would-be readers lacking fluent English can seek out more able friends to translate in detail items of special interest.

MIDLANDS E.R.C.C.

FORMULA 12th 1977-78 CHAMPIONSHIP

Report by Arthur Home

Round 1: Mardaves invade Lectricar Country

17th November, 1977.

With the 1/12th Mardave electriccar now available to all to the Lectricars there was a good turnout of twenty cars for this first round, with some notable drivers from 1/8th glowplug racing keeping their hands in during the winter. Dave Preston had a Mardave, daughter Debbie trying a Marker; world stock car champions past and present Steve Talbot and Dave Wragg with their Lectricars. Thanks to slick organising and timekeeping by Bob Pulham every driver had five five-minute

SHOPPING AROUND

FIRST event of the New Year was undoubtedly the *Model Engineer* Exhibition at Wembley, where some 80,000 visitors passed through the doors, an appreciable number making their way down to the Avon Room where the Terrible Twins Ted Longshaw and Phil Greeno held sway. The shot of their stand is a posed picture — we had to beat back the crowd to get the camera in edgeways, ask Ian Skilling of Eltham Models, he helped push them back! Apart from any little thing like a profit this presence will have done an amazing amount of good in bringing the strength of the movement before an uncommitted section of the modelling public. Roger Wilding of Modelcraft from Blaby, the main Midlands Mardave retailer was lucky enough to have his stand in the main hall, by virtue of a 50/50 committal to steam projects, and he too played a significant and profitable part, though handicapped by the sudden illness of his assistant, now happily at home again. Electric car racing in a kind of birdnetted fruitcage was little more than a taster but the boys (and girls) did their best!

The long awaited MRP electric cars have arrived, and in a flash virtually disappeared, snapped up by the eager public. At last look Keith Plested could only offer the super-de-luxe all-in version, and any spare part you like to mention. By the time this appears the next batch should be in with a more optimistic order size. Those lucky enough to have one report quite



Boys and girls come out to play! On second thoughts we liked this picture of Phil Greeno, Mrs. Greeno and Ted Longshaw in the birdcage trying out Mardaves against Jerobee... better than the hard won stand shot mentioned in the text... perhaps next time. (Photo: Paul Barrett).

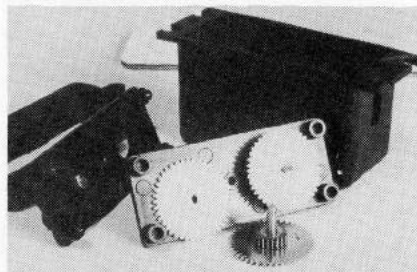

You want a super servo? Then let World Engines' Mick Wilshere build you one with brass, steel, nylon gears to your choice.

exciting results and all the performance we have been led to expect. A big range of bodyshells, both clear Lexan or ready painted are of course compatible with any of the 1/12th scale cars.

The Red Baron is enthusiastic about his latest runner from the Irvine stable, this time 1/12th glowplug 1 1/2cc, in the shape of a very beautifully diecast Lamborghini bodied car, with — hold it — both forward and reverse. I saw the first kit some time ago at High Barnet and can vouch for the quality of the work. The engine lies flat and so does not detract from the body shape: fuel tank is an integral diecasting. I hope to have a chance to build one up to try against the SG car described elsewhere in this issue. This makes two with Irvine Engines, since they have been handling the near RTR Sanwa 1/12th scale car

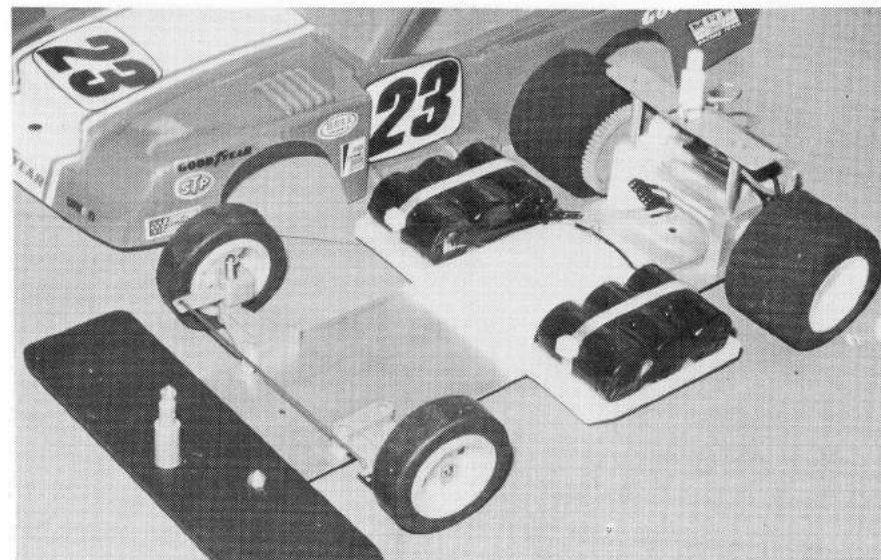

The long awaited MRPs duly arrived and were swallowed up in the rush. This is the lowest priced "cooking" version with "slot-car" type wipe rheostat speed control.

complete with Rx and Tx, surely the mostest for the money and particularly suited to the younger entry... though perhaps not quite up to top racing standards without some breathing upon.

Already the 1/12th division is beginning to breed its own range of speciality accessories. We have fitted the very elegant polished alloy front wheels and matching rear nave plates to our Mardave electric, and am using the Tamiya racing slicks at the front, which perform most admirably. I had already tried them out when running on tarmac at the Pontins Holiday Week last autumn.

We are happy to welcome news of the Dutch home bred car kit, raced by many local users, and showing up as fifty per cent of the Dutch team at Lyons last year. This is a very elegant kit, with a lot of likeable features, particularly the front end, with one of nicest steering set-ups; and now with the option of disc brakes to bring the rear end in line with modern thinking. Like so many things it is hard to pin point a best since it all depends on the driver: all one can really do is mention a good buy — which is specially important if other people in the club are fellow users. I have just had a visitor from overseas with a remarkably polyglot car — it must have a part or two

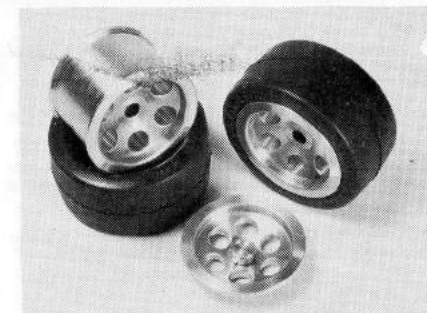

Modelcraft's handmade alloy wheels and hub inserts for Mardave. Front wheels use Tamiya racing slicks — they work fine!

The deluxe (radio, servos, the lot) MRP power end showing clever heatsink for the speed control.

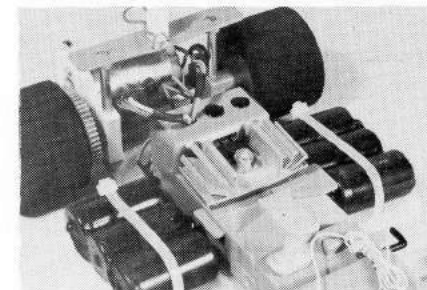

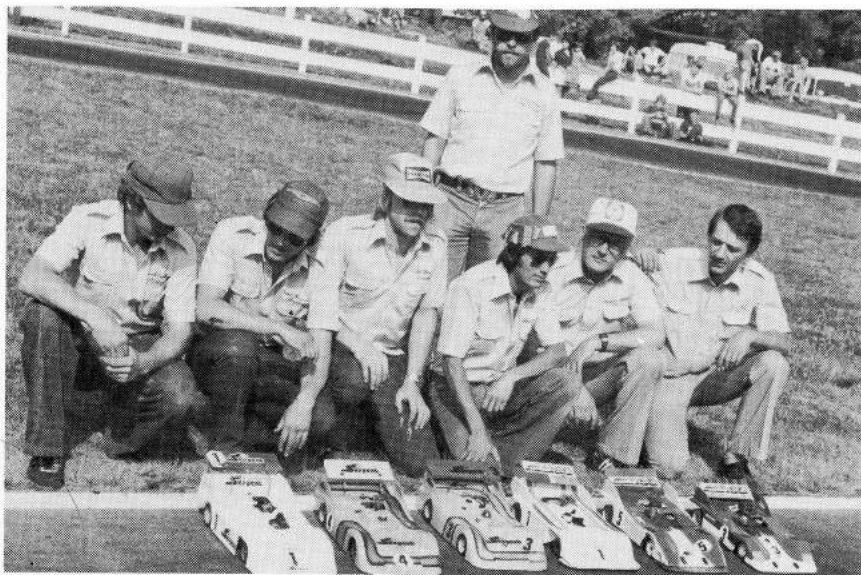

Dutch team shot from Lyons. Fifty/fifty Serpents and SGs. Left to right: Frank Cromberg (Serpent/K&B), Pieter Bervoets (Serpent/K&B), Ad Box (Serpent/ST), Albert Meijer (SG/ST), Herman Sukkel (SG/ST) and Ron Ton (SG/K&B & ST). Standing: Gerald Hoogeveen — Team Leader.

Nut driver set acquired in Lincoln — made for the Tandy group 5mm up to 10mm hex.

The new Serpent disc brake. Practical and just about the simplest possible impossible to go wrong unit.

A racing "must": the Big Shot fuel bulb — experts fit a larger gauge brass tube for quicker filling.

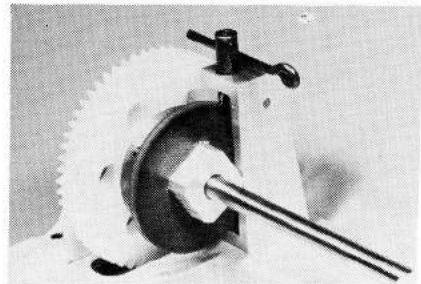
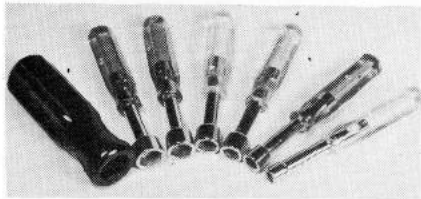

from nearly every manufacturer plus some bits scratch built — and by that reasoning should not be ideal. Track record denies this, however, his car is usually in the top half dozen at top level racing!

Readers will remember Richard Hamilton who wrote in about Fred Livesey No. 1 issue tuning article. Well, Richard is putting his money down on the modelling drum, as the co-proprietor of Egham Radio Models, who announce their opening in this issue. Welcome to the right sort of modelshop man, the practical enthusiast... may good fortune and prosperity attend your efforts. In this vein, we must read some special interest in Ted Longshaw's throwaway line, with his invitation to visit at Biggin Hill Showrooms... "until negotiations for a shop are completed"... That will, indeed, be the day, with racing in the streets...

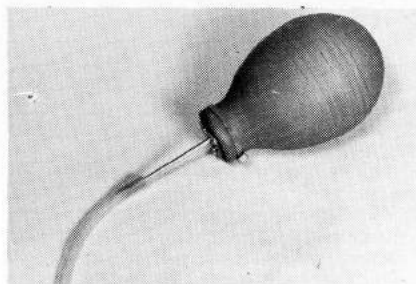

CHESSINGTON

CHESSINGTON RADIO CAR CLUB (CRCC)

Chairman: Vern Cousins.

Vice-Chairman: Jack Bye.

Secretary: Miss Linda Woolger.

Chairman Race Committee: Paul Ekins.

Track Location: R.A.F. Chessington, Mansfield Road, Chessington, Surrey. (Open for racing Sundays 2— 6 p.m.).

Club Meetings Held at: North Star Public House, Hook Road, Chessington, Surrey. (Every third Wednesday in the month).

INTEREST in this area of S.W. London was originally started in February 1975, when a race meeting was organised by several keen enthusiasts of the sport. The Club was formed as a Section of another club, namely Surbiton Town Sports Club. Members used the go-karters' track for practice only; it was not suitable for racing. No reasonable track site was readily available and the Club's activities were centred at various locations. An unused asphalt area was found on a Purley Industrial site, and the Club raced there until the use of the site was ultimately denied. The track at Surbiton was eventually improved, but it was still too rugged for the 1/16 in. scale Formula 1, GT Sport and Stock Cars. The stock cars

follow RSCA rules where possible, and with regard to Formula 1 GT Sport racing cars the BRCA promotes these and their rules closely follow their full-size counterparts where possible. An alternative site was needed — members were not renewing their subscriptions — they had nowhere to race!

The present site was adopted in Summer 1976, when the Club was permitted to visit the R.A.F. Medical Rehabilitation Unit at Chessington on two Saturday afternoons per month. Membership increased. Permission was given for the Club to use the huge tarmaced area, where we have no permanent track laid down as yet, but mark out various tracks using tyres, etc., for the GT Sports leaving enough room for a stock car circuit, made up of an inner oval of plywood strips with an outer fencing constructed of old floor boarding.

During 1977 many club and inter-club meetings and demonstrations for fetes and charity functions have been held, and these demonstrations have been run as official race meetings, to the delight of the crowds, with trophies being awarded donated by the organisers of the fetes.

(continued on page 57)



Doug Kightley's classic "burnout". It looked much more spectacular in colour but this does give an idea.

LETTERS...

HELP!

Dear Sir,

I write to protest at the contents of Issues 1 and 2 of *Radio Control Model Cars*, an elitist magazine, destined, it would seem, for the expert vociferous few. Frankly, as I recall the competitions I entered last year, I feel that an engine tuning article is the very last thing needed; the only result is likely to be that the other competitors will crash their cars into mine even harder than they did last year. How about an article, or even a series, on **how to win my first race?**

Rex Watson
Auto Model Club de Geneve.

R/C DRAG RACING ENTHUSIASTS WANTED

Dear Editor,

I enclose a photo of my 1/8th car based on a drag racing "Funny Car" doing a flame burn-out which I performed to a few thousand spectators at Santa Pod Raceway last November 5th. It was in fact the second burn-out I did that night and surprisingly enough the car survived! The car is scratchbuilt with a Capri body and intended to do the full 1/4 mile at Santa Pod, and in fact, has done it twice in practice, but crashed during a timed run at about

50mph when a cross wind blew it off course.

It lay in mothballs until I met another r/c dragster, John Platt of Fleetwood. I then prepared the car again for running and worked out a flame-out routine and did it on bonfire night! I have now made contact with two other r/c drag racing experimenters and would like to find out if there are any more interested in getting drag racing going in this country as it is in the States. Also I should like if possible to get up a drag racing demonstration for Santa Pod. I am in touch with the Track Manager, who is an r/c flying buff, and he is keen to get a good model drag demo going to keep the crowds happy during lunch breaks, etc. More information can be obtained direct from me (or telephone 0602-52276).

40 Hickling Road Doug Kightley
Mapperley
Nottingham NG3 6GW

RACING COSTS — YES, THERE IS AN ANSWER!

An Open Letter to Derek Smith of Lenham.

Dear Derek,

Don't give up hope! The Mardave Owners' Club has been successfully operating low cost racing at its Newbridge Circuit over the past three seasons, and

have tried to get a similar system accepted nationally, but to no avail. All the Sports/F1 meetings listed below will be run on to three classes based on the cost of the car/engine and you will be most welcome to take part as these are all Open Meetings as defined by BRCA: F1/Sports 2nd April, 21st May, 11th June, 30th July, 1st October.

Class A: Car & Engine not to exceed £60. Class B: Car/engine not to exceed £90. Class C: Unlimited cost. Certain mods. are allowed in A & B classes so there is no fear of stagnation. Competition is fierce in all classes and Trophies are awarded in each class. So if yours costs less than £60 you can still enjoy a good day's racing.

Your point on piston liners of Veco 19 was covered in Fred Livesey's article in Issue No. 3. I should like to confirm that McCoy Stage 1 conversion is well worth it. I have run one for two seasons and am still on my second Dyke's ring. I have, however, had to replace the aluminium piston along with a couple of other club members when the gudgeon pin holes elongated slightly but we had no trouble with the new ones.

Yours sincerely,
Stewart Busby.

ANOTHER EX-CABLE CAR MAN

Dear Dickie,

I have been running the old tethered cars and I am toying with the idea of converting them to radio control. I see Jim Batten has done just that from the Pontin's holiday photographs. We have had a lot of fun with the tethered cars and I managed to get in touch with one of the old boys who used to race them — Jack Morgain.

You asked for ideas concerning Radio Control Model Cars — I wondered if plans could be made available for the old type cars, I was thinking in terms of Alfa 158 or the Delage. I think these would make nice radio models.

The only snag with these is lack of room for radio gear, although I think this can be done judging by what Jim has done. I would like to congratulate you on the magazine which is on the style of *Model Car News* which I thought was good. I don't suppose you could lay your hands on D. A. Russell's SS100 plan? I think this would be ideal for r/c; I have collected the ashtray tyres and turned up the hubs for it.

All the best to the magazine, long may it reign.

Yours faithfully,
Leonard A. Wortley.

Gt. Yarmouth.

TYRE DATA REQUIRED

Dear Editor,

So you have a "Bee in Your Bonnet" stung into action by model car tyres! I happen to be a tyre engineer with one of the full size tyre companies you list. Although no newcomer to radio control; I have been building planes and boats since the hard valve days, my experience with model cars is zero. Your "Ignorance is not Bliss" item has, however, roused my interest to the extent that I have now ordered my first car kit. First I intend to explore tyre requirements for these models.

This will take time, because tyre exploration is not possible unless I become proficient at handling during testing.

In the meantime, I would be very interested to hear from those who have mastered the art, and have formed some idea of what is required; this could advance my programme considerably. Even more so, I would like to hear of things that do not work.

I stress that at this stage, my company are not involved in the exploration, it is a private venture. Being a keen modeller, however, I am on your side, and shall not miss any opportunity of helping our cause.

Yours sincerely,
Bill Wells

3 Avon Road
Melksham
Wilts. SN12 8AY

CHESSINGTON (Cont.)

Tentative bookings have already been made for the 1978 calendar, but there is always room for more! The Club started the new year off well, by providing a demonstration at Wimbledon Stadium for Spedeworth Motor Racing, which provided hundreds of people with an insight into our sport. This promoted newspaper articles to be written about our club, and even a chance to appear on the television.

Although only a young Club, with members now numbering nearly fifty, Chessington Radio Car Club has already made its mark in the National racing scene. Some members of the Club, both GT Sport and Stock Cars, have raced at other Club meetings at various times during 1977, obtaining experience and skill in manoeuvring around different types of tracks. Members are always willing to offer advice and assistance to the newcomers, as we all know once you have joined a club your experience increases and therefore you become a better driver.



Ted Longshaw reports: Luxembourg back in the fold, absence at AGM due to a misunderstanding — and they have in fact paid their fee for 1978. Which leads naturally to the reminder that national organisations who have **not** should send before February 15th (after this comes out!) to Max Zaugg, Spitzackerstr. 9, 8304 Wallisellen, Switzerland.

EFRA MEETINGS

Switzerland A.M.C. Geneva had to change July meeting to 22nd-23rd. Sweden who altered their date to help out would maybe now like to change back to

NATIONAL ASSOCIATION ADDRESSES 1978

Austria

J. Maringer
Haunspergstr 21
A-5020 SALZBURG

France

Patrick Rigot
12 Villa du Petit Parc
94000 CRETEL

Holland

Gerard J. Hoogeveen
Franz Leharlaan 26
2102 GP HEEMSTEDÉ

Luxembourg

Noel Francis
16 Dierwies
ECHTERNACH
G.D. Luxembourg

Switzerland

Leo Jost
Postfach B 1454
CH 8302 KLOTEN

PRESIDENT

Ted Longshaw
Beech Tree House
West Hill, Downe
ORPINGTON Kent
England

Finland

K. Kansakoski
Vahantuvantie 6 B 21
00390 helsinki 39

Great Britain

Tom Martin
7 The Green
Werrington
Peterborough, Cambs

Leichtenstein

M. Platel,
25 Av. du Rignon,
GENEVA.

Spain

C. Merseburger
Traversera de la Corts 198
Barcelona.

Belgium

Philippe Roussel
Rue Longue 168
1150 Bruxelles

Germany

Wolfgang Ribatzky
Bahnhofstr. 21
D-7911 THALFINGEN
West Germany

Italy

Guerrino Stanzani
Via Sacconi 13
51100 PISTOIA

Monaco

P. Rinaldi
14 ave. de Fontvieille
Monaco

Sweden

Siv Mosen
c/o SBF Box 4
S-12321 FARSTA

their original 1st-2nd date (advise check before going!)

Spadework at Lilford Park now complete making it one of Europe's top circuits. Meeting on May 6th-7th offers chance for a spot of training in readiness for big August meeting.

PORTUGAL

Interest rising fast (*one of our better importing countries for the mag Ed.*) and reports of a track being built at Estoril . . . New member country soon for EFRA we hope.

SWEDEN

Rolf Stahre writes that a track is to be built inside Arctic Circle! Building plans in Sweden include three to six new purpose built circuits likely during the year.

MONACO

World Cup Formula event in May will be limited to forty-eight of the World's Top Drivers. Five American drivers expected plus the best of Europe's drivers. (*Who these will be is still a problem — for one thing National winners' list in Italy full of unknowns with the famous right out of the running. Ed.*)

RACING CALENDAR 1978

All dates provisional until announced by clubs & organisers

| DATE | BRCA | EURO | INVITATION |
|--|--|--|---|
| Mar. 5 18/19 25/26/27 | Mendip 3 class | Euro G.P. Germany | Mendip G.T. Newbridge Sal/Nov |
| Apr. 1/2 8/9 15/16 22/23 29/30 | Wombwell F1/GT Bournemouth F1/GT Bradford 3 class Mendip 3 class | Euro G.P. Toulon | Newbridge F1/GT Newbridge Sal/Nov |
| May 1 6/7 13/14 20/21 27/26/29 | Lilford European GP Tibshelf F1/GT Wombwell Nats | Euro GP Lilford Euro GP Holland Monaco World Cup * | Newbridge F1/GT |
| June 3/4 10/11 17/18 24/25 | Newbridge F1/GT Wombwell 24 hr Catfoss F1/GT | Euro GP Italy Utrecht Invitation * | Newbridge Sal/Nov Mendip F1/GT |
| July 1/2 8/9 15/16 22/23 29/30 | Wrexham F1/GT Mendip F1/GT Lilford * British Team Invitation | Euro GP Switzerland Euro GP Sweden * | Bradford Mini Marathon Tibshelf 6 hour Newbridge F1/GT |
| Aug. 5/6 12/13 19/20 26/27/28 | Lilford Euro * Championships Wombwell F1/GT Tibshelf F1/GT | Euro Championships Lilford* | Wirral F1/GT |
| Sept. 2/3 9/10 16/17 23/24 | Bradford 3 class Bournemouth F1/GT | Euro GP Belgium Heemestede 4 hr * | Mendip F1/GT Newbridge Charity GP |
| Oct. 1 7/8 15 21/22 28/29 | Newbridge F1/GT | Euro GP Spain | Newbridge Sal/Nov |
| Nov. 4 | | | Mendip F1/GT |

* Non-points meetings. All meetings in BRCA and Euro Calendars other than those so marked to be points-score meetings. Points-score meetings in BRCA Calendar to count for handicap revision.

With four meetings carried over from the 1977 Calendar (Tibshelf, Bradford, Newbridge and Catfoss) held in August or September which count in the current points series, this Calendar allows not more than two meetings at any one circuit to be recognised in the 1977/78 points year. It also gives no circuit more than one meeting which will count in the 1978/79 points year.

Radio Control Model Cars acknowledges with thanks early sight of this list which was prepared with considerable midnight oil and hard labour by BRCA SECRETARY Tom Martin.

A NEW MODEL SHOP!!

Egham Radio Modeller and Engineer

23, VICTORIA STREET, ENGLEFIELD GREEN, EGHAM, SURREY. PHONE EGHAM 5636

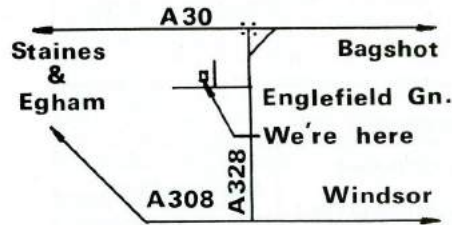

**LATE NIGHTS MONDAY
AND FRIDAY (8 o'clock)**

Cars by PB, Associated
Engines by K&B, S.T.,
OPS, Veco, McCoy
Radio by Futaba
Tyres by Associated, PB,
Delta, Ultimara
Loads of spares!! Also
planes, boats & helicopters

MICHAEL'S MODELS

646-648 High Road,
N. Finchley, N12 0NL
Telephone: 01-445-6531

CAR KITS by Mardave, P.B., Ke'Jon,
Lectricar.

ENGINES by Super Tigre, O.P.S., K&B,
Veco, Enya.

P.B. International Kit **£75.00**

K&B 21 R/C **£47.50**

P.B. Heatsink head for K&B, Veco **£7.50**

Lectricar with proportional speed control,
Porsche 911, Escort, Porsche 936 **£44.87**

Full range of spares. Send S.A.E. for list of
Kits, Engines.

Phone your Credit Card Number for same
day service. Access, Barclaycard, Carte
Bleu, Eurocard, Mastercharge, Visa, Bank
America Card

Graber models

15 Abbey Road, Torquay, Devon
Telephone: 0803 211656

Hours: 9.15-8.00 Mon to Sat Half Day Wed

KITS

| | |
|-----------------------------|--------|
| PB International | £75.00 |
| PB Expert Competition | £81.38 |
| PB Expert Standard | £45.04 |
| GB Ballraced | £38.07 |
| Puma Super Stocker | £32.40 |

RADIO BY SKYLEADER, SANWA,
WALTRON, WORLD, FUTABA & HORIZON
Range of P.B. & G.B. Spares & Accessories

READYBUILT P.B. EXPERTS with Veco 19
Motor and World Engines all Nicad Radio, with metal gear
servos.

| | |
|--|------|
| Standard Model (Plain Bearing) | £140 |
| Competition Model (Ballraced) | £156 |

Supplied with one body only ready sprayed with decals.
State body required and colour choice.
(post Free U.K.)

G.T. Bodies: Porsche 917/30KL, Lola G.T., Wolf G.T.
Formula 1 Bodies: Surtees TS14, Indy F.I.

Mail Order Worldwide

SAE or IRC with all enquiries please

THE RIGHT FORMULA FOR YOUR CAR!
DIGIACE KO V2
SEE IT IN YOUR MODEL SHOP NOW

SPECIAL FEATURES

High Power High Speed Servos
5lbs. Pull at 1/2 inch Radius. 0.3 Sec/70 Deg
Tx & Rx Tuned for Operation at 10 KHz
Dual Neutral Facility on Throttle/Elevator
Adjustable Length Control Sticks
Standard Size Lightweight Tx
Large Tx Meter

£65.00 Inc. VAT Standard Servos

£69.00 Inc. VAT Ball Bearing Servos

OPTIONS 225 or 450 mA Nicad & Switch Harness **£9.75**
Charger 110 or 240v **£8.00**



Importers and Concessionaires

FLIGHT LINK CONTROL LTD
BRISTOW WORKS, BRISTOW ROAD,
HOUNSLOW, MIDDLESEX.
01-570-4065 (24 hour ansaphone)

TELEPHONES

Northern Distributors

C. I. & R. A. THOMPSON (Kits & Accessories)
132 SLAITHWAITE ROAD,
MELTHAM, WEST YORKS. HD7 3PW
Huddersfield (0484) 851433

PB PRODUCTS

FAMOUS FOR THE "INTERNATIONAL"

NOW OFFER

MRP

1ST. & FOREMOST

1/12 Electric
Range



6-cell
car ready to
run including RX
& TX, steering servo
electronic speed control
& recharging lead-J910. Or:
Complete as above without
TX — J910-0

FROM

£59.95



Some of the wide range of spares; Moulded aerodynamic wing; 6-cell ready wired pack; electric motor prewired with plug; chromed wheels hubs; choice of tyres, including silicone coated, foam etc., tyres wheels trued & glued; resistor speed control unit; choice of moulded gears and brass pinions. The lot!

Trade enquiries welcome.

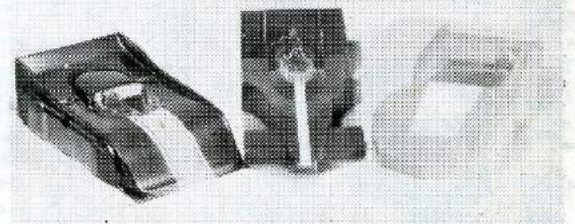

Body shells in Lexan, painted or unpainted clear for F1 Shadow; GT Alfa; Saloon Corvette; Saloon VW Bug; GT Lola T282; GT Porsche 917 Saloon Ferrari; F1 Surtees TS14; GT Abarth; F1 Renault. Painted bodies finished but untrimmed. All with front body mounts to suit. Below: Basic car J929: 6-cell without radio, but including variable resistor speed control, prewired, recharging lead.

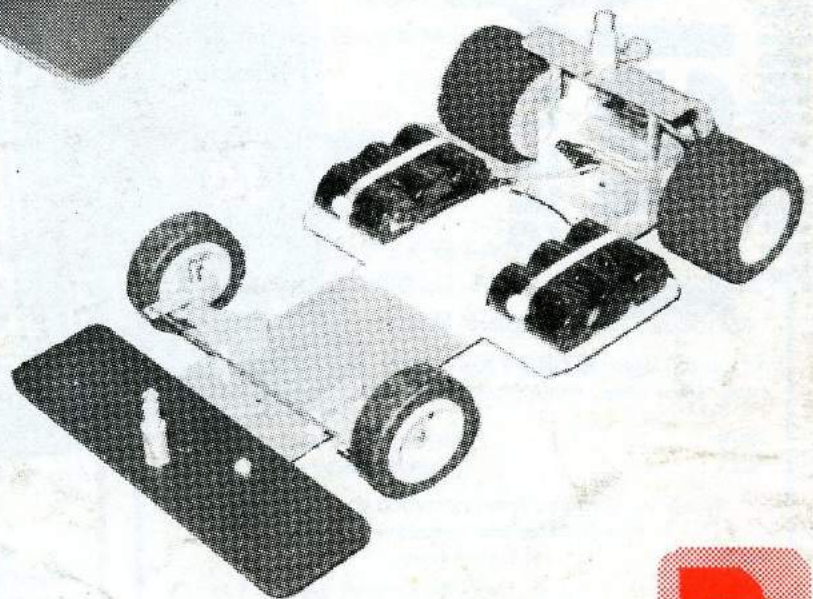
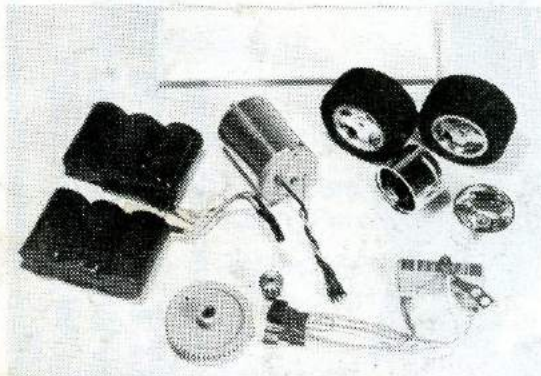

**PB PRODUCTS DOWNLEY RD
HAVANT HANTS Tel. HAVANT (0705) 471774**

